

# iMaster-C1 INSTRUCTION MANUAL

**Precautions**

Keep this manual close to the handler responsible for the operation and maintenance inspection. Be sure to familiarize yourself with the handling manual before performing an inspection, and use it correctly according to the instructions of the instrument's knowledge, safety information, precautions, operation, and handling methods.

Always observe the various specifications in the handbook.

Also, perform the correct inspection and repair to prevent the failure.

**Warranty for the unit**

The warranty period for the delivery product is one year after delivery to the designated place of the order.

In the event of a failure under normal use within the product specifications in accordance with this manual, the defect shall be replaced or repaired free of charge.

However, the warranty will be void if the fault is due to:

- (1) In case of unfair treatment and use by the consumer;
- (2) If the cause of failure is due to a reason other than the product supplied,
- (3) In case of modifications or repairs other than suppliers;
- (4) In case the supplier is not responsible for other natural disasters or disasters;

In addition, the warranty is for the inverter only, any damage caused to other equipment by malfunction of the inverter is not covered by the warranty.

**Repair cost**

Any repairs after the warranty period (1 year) will be paid. In addition, even during the warranty period, repairs for reasons other than the above warranty coverage and investigation into the cause of failure will be treated as a charge.

Please contact your place of purchase or service center – please refer to the list of back cover.

**Questions on Unit**

If you have any questions regarding damage to the unit, unknown parts or for general inquiries, please contact service center with the following information.

- (1) Date of purchase
- (2) Company name of purchase
- (3) Manufacturing number (MFG. No.)
- (4) Failure details (as detailed as possible)

## SAFETY

- FOR THE SAFE OPERATION OF THE IMASTER-C1 SERIES VFD, READ THIS MANUAL AND ALL OF THE WARNING SIGNS ATTACHED TO THE INVERTER CAREFULLY BEFORE INSTALLING AND OPERATING IT, AND FOLLOW THE INSTRUCTION EXACTLY. KEEP THIS MANUAL HANDY FOR YOUR QUICK REFERENCE.

## SYMBOLS AND DEFINITION

- A SAFETY INSTRUCTION (MESSAGE) IS GIVEN WITH A HAZARD ALERT SYMBOL AND/OR A WARNING or CAUTION.
- EACH SIGNAL HAS THE FOLLOWING MEANING THROUGHOUT THIS MANUAL



### HAZARDOUS HIGH VOLTAGE.

IT USED TO CALL YOUR ATTENTION TO ITEMS OR OPERATIONS THAT COULD BE DANGEROUS TO YOU OR OTHER PERSONS OPERATING THIS EQUIPMENT.  
READ THESE MESSAGES AND FOLLOW THESE INSTRUCTIONS CAREFULLY.



### SAFETY ALERT SYMBOL

THIS SYMBOL IS USED TO CALL YOUR ATTENTION TO ITEMS OR OPERATIONS THAT COULD BE DANGEROUS TO YOU OR OTHER PERSONS OPERATING THIS EQUIPMENT.  
READ THESE MESSAGES AND FOLLOW THESE INSTRUCTIONS CAREFULLY.



### WARNING

INDICATES A POTENTIALLY HAZARDOUS SITUATION WHICH, IF NOT AVOIDED, CAN RESULT IN SERIOUS INJURY OR DEATH.



### CAUTION

INDICATES A POTENTIALLY HAZARDOUS SITUATION WHICH, IF NOT AVOIDED, CAN RESULT IN MINOR TO MODERATE INJURY, OR SERIOUS DAMAGE OF PRODUCT.  
THE MATTERS DESCRIBED UNDER  **CAUTION** MAY, IF NOT AVOIDED, LEAD TO SERIOUS RESULTS DEPENDING ON THE SITUATION. IMPORTANT MATTERS ARE DESCRIBED IN **CAUTION** (AS WELL AS WARNING), SO BE SURE TO OBSERVE THEM.

### NOTE

INDICATES AN AREA OR SUBJECT OF SPECIAL MERIT, EMPHASIZING EITHER THE PRODUCT'S CAPABILITIES OR COMMON ERRORS IN OPERATION OR MAINTENANCE.



### HAZARDOUS HIGH VOLTAGE

- MOTOR CONTROL EQUIPMENT AND ELECTRONIC CONTROLLERS ARE CONNECTED TO THE HAZARDOUS LINE VOLTAGE.
- WHEN SERVICING VFD AND ELECTRONIC CONTROLLERS, THERE MIGHT BE EXPOSED COMPONENTS OR ABOVE LINE POTENTIAL.
- EXTREME CARE SHOULD BE TAKEN TO PRODUCT AGAINST SHOCK. STAND ON AN INSULATING PAD AND MAKE IT A HABIT TO USE ONLY ONE HAND WHEN CHECKING COMPONENTS.
- ALWAYS WORK WITH ANOTHER PERSON IN CASE AN EMERGENCY OCCURS.
- DISCONNECT POWER BEFORE CHECKING CONTROLLER OR PERFORMING MAINTENANCE.
- BE SURE EQUIPMENT IS PROPERLY GROUNDED. WEAR SAFETY GLASSES WHENEVER WORKING ON AN ELECTRIC CONTROLLER OR ROTATING ELECTRICAL EQUIPMENT.

**PRECAUTION**

- A SAFETY INSTRUCTION (MESSAGE) IS GIVEN WITH A HAZARD ALERT SYMBOL AND A WARNING or CAUTION.



**WARNING** THIS IS EQUIPMENT SHOULD BE INSTALLED, ADJUSTED AND SERVICED BY QUALIFIED ELECTRICAL MAINTENANCE PERSONAL FAMILIAR WITH THE CONSTRUCTION AND OPERATION OF THE EQUIPMENT AND THE HAZARDS INVOLVED. FAILURE TO OBSERVE THIS PRECAUTION COULD RESULTS IN BODILY INJURY.



**WARNING** THE USER IS RESPONSIBLE FOR ENSURING THAT ALL DRIVEN MACHINERY, DRIVE TRAIN MECHANISM NOT SUPPLIED BY HYUNDAI AND PROCESS LINE MATERIAL ARE CAPABLE OF SAFE OPERATION AT AN APPLIED FREQUENCY OF 150% OF THE MAXIMUM SELECTED FREQUENCY RANGE TO THE AC MOTOR. FAILURE TO DO SO CAN RESULT IN DESTRUCTION OF EQUIPMENT AND INJURY TO PERSONNEL SHOULD A SINGLE POINT FAILURE OCCUR.



**WARNING** FOR PROTECTION, INSTALL AN EARTH LEAKAGE BREAKER WITH A HIGH FREQUENCY CIRCUIT CAPABLE OF LARGE CURRENTS TO AVOID AN UNNECESSARY OPERATION. THE GROUND FAULT PROTECTION CIRCUIT IS NOT DESIGNED TO PROTECT PERSONAL INJURY.



**CAUTION** HEAVY OBJECT. TO AVOID MUSCLE STRAIN OR BACK INJURY, USE LIFTING AIDS AND PROPER LIFTING TECHNIQUES WHEN REMOVING OR REPLACING.



**CAUTION** THESE INSTRUCTIONS SHOULD BE READ AND CLEARLY UNDERSTOOD BEFORE WORKING ON IMASTER-C1 SERIES EQUIPMENT.



**CAUTION** PROPER GROUNDS, DISCONNECTING DEVICES AND OTHER SAFETY DEVICES AND THEIR LOCATION ARE THE RESPONSIBILITY OF THE USER AND ARE NOT PROVIDED BY HYUNDAI.



**CAUTION** BE SURE TO CONNECT A MOTOR THERMAL SWITCH OR OVERLOAD DEVICES TO THE IMASTER-C1 SERIES VFD TO ASSURE THAT INVERTER WILL SHUT DOWN IN THE EVENT OF AN OVERLOAD OR AN OVERHEATED MOTOR



**CAUTION** ROTATING SHAFTS AND ABOVE GROUND ELECTRICAL POTENTIALS CAN BE HAZARDOUS. THEREFORE, IT IS STRONGLY RECOMMENDED THAT ALL ELECTRICAL WORK CONFORM TO THE NATIONAL ELECTRICAL CODES AND LOCAL REGULATIONS. ONLY QUALIFIED PERSONNEL SHOULD PERFORM INSTALLATION, ALIGNMENT AND MAINTENANCE. FACTORY RECOMMENDED TEST PROCEDURES, INCLUDED IN THE INSTRUCTION MANUAL, SHOULD BE FOLLOWED. ALWAYS DISCONNECT ELECTRICAL POWER BEFORE WORKING ON THE UNIT.

**NOTE: POLLUTION DEGREE 2**

- THE VFD MUST BE USED IN THE ENVIRONMENT OF THE POLLUTION DEGREE 2.
- TYPICAL CONSTRUCTIONS THAT REDUCE THE POSSIBILITY OF CONDUCTIVE POLLUTION ARE,
  - 1) THE USE OF AN UNVENTILATED ENCLOSURE.
  - 2) THE USE OF A FILTERED VENTILATED ENCLOSURE WHEN THE VENTILATION IS FAN FORCED THAT IS, VENTILATION IS ACCOMPLISHED BY ONE OR MORE BLOWERS WITHIN THE ENCLOSURE THAT PROVIDE A POSITIVE INTAKE AND EXHAUST.

## CONFORMITY TO THE UNDERVOLTAGE DIRECTIVE (UVD)

THE PROTECTIVE ENCLOSURE MUST CONFORM TO THE UNDERVOLTAGE DIRECTIVE. THE VFD CAN CONFORM TO THE UVD BY MOUNTING INTO A CABINET OR BY ADDING COVERS AS FOLLOWS.

### CABINET AND COVER

THE VFD MUST BE INSTALLED INTO A CABINET WHICH HAS THE PROTECTION DEGREE OF TYPE IP2X.

IN ADDITION THE TOP SURFACES OF CABINET ARE EASILY ACCESSIBLE SHALL MEET AT LEAST THE REQUIREMENTS OF THE PROTECTIVE TYPE IP4X, OR WHICH IS CONSTRUCTED TO PREVENT SMALL OBJECTS FROM ENTERING INVERTER.

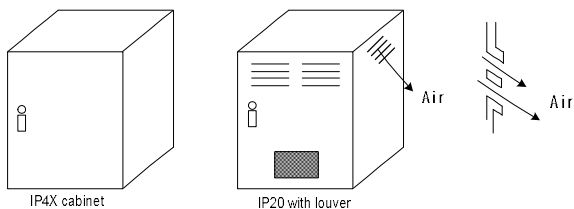

**Fig 1. INVERTER CABINET**

**General Safety Information**

A SAFETY INSTRUCTION (MESSAGE) INCLUDES A HAZARD ALERT SYMBOL AND A SIGNAL WORD, DANGER OR CAUTION. EACH SIGNAL WORD HAS THE FOLLOWING MEANING: THIS SYMBOL IS THE "SAFETY ALERT SYMBOL." IT OCCURS WITH EITHER OF TWO SIGNAL WORDS: DANGER OR CAUTION, AS DESCRIBED BELOW.

**DANGER**

: INDICATES A POTENTIALLY HAZARDOUS SITUATION WHICH, IF NOT AVOIDED, CAN RESULT IN SERIOUS INJURY OR DEATH.

**CAUTION**

: INDICATES A POTENTIALLY HAZARDOUS SITUATION WHICH, IF NOT AVOIDED, CAN RESULT IN MINOR TO MODERATE INJURY, OR SERIOUS DAMAGE TO THE PRODUCT.

THE SITUATION DESCRIBED IN THE CAUTION MAY, IF NOT AVOIDED, LEAD TO SERIOUS RESULTS. IMPORTANT SAFETY MEASURES ARE DESCRIBED IN CAUTION (AS WELL AS DANGER), SO BE SURE TO OBSERVE THEM.

** CAUTION**

- All illustrations in this handbook may be depicted with the cover or blockage removed to explain the details.  
When operating the machine, operate the machine in accordance with the handling manual, with the specified covers.
- No notification is given if the contents change due to product improvement or manual re-organization. The changes are indicated by the number in the revised manual.
- If you have lost or damaged the manual, please contact your dealer or your nearest dealer.
- Product damage caused by user arbitrary operation is not within the scope of maintenance and is not liable for it.

**General Safety Information****1. Installation** **CAUTION**

- Be sure to install the unit on flame resistant material such as metal.
- Be sure not to place anything highly flammable in the vicinity.
- Do not carry unit by top cover, always carry by supporting base of unit.
- Be sure not to let foreign matter enter VFD such as cut wire refuse, spatter from welding, iron refuse, wire, dust, etc.
- Be sure to install inverter in a place which can support the weight according to the specifications in the text. (Chapter 2. Installation)
- Be sure to install the unit on a perpendicular wall which is not subject to vibration
- Be sure not to install and operate a VFD which is damaged or has parts which are missing.
- Be sure to install the inverter in an area which is not exposed to direct sunlight and is well ventilated. Avoid environments which tend to be high in temperature, high in humidity or to have condensation, as well as places with dust, corrosive gas, explosive gas, highly flammable gas, grinding-fluid mist, salt damage, etc.

**2. Wiring** **CAUTION**

- Be sure to ground the unit.  
Electrical wiring work should be carried out by qualified electricians.
- Do the wiring work by an electrician.  
There is a possibility of electric shock and fire.
- Check the input power OFF before wiring.  
There is a possibility of electric shock and fire.
- Be sure to attach the main body and wire it.  
There are concerns of electric shock and injury.



## General Safety Information

### CAUTION

- Make sure that the rated voltage and AC power voltage of the product match.  
There are concerns about accidents and fires.
- Do not use single phase input.  
There is a fire hazard.
- Do not connect AC power to the output terminals (U,V,W).  
Risk of injury and fire.
- Tighten to the specified torque of the screw. Check that the screws are not loose.  
There is a fire hazard.
- Install a short circuit breaker on the input side.  
There is a fire hazard.
- Install the fuse in the operating circuit (same as main power).  
There is a fire hazard.
- Use power lines, short-circuit breakers and electronic contactors at the specified capacity (qualification).  
There is a fire hazard.

## 3. Control and Operation

### CAUTION

- Be sure to put the input power after you remove the front cover.  
Do not open the cover while it is energized.  
There is a possibility of electric shock.
- Do not operate the switch with wet hands.  
There is a possibility of electric shock.
- Do not contact the inverter terminals during powering or shutdown of the inverter.  
There is a possibility of electric shock.
- If retriever mode is selected, a sudden restart will occur even the inverter stopped by trip.  
(Please designed a machine can protect with retriever mode.)  
Please keep away from the machine. There are concerns of an accident.
- If a short power outage occurs, the driver's command can be entered to re-run after the power outage. If there is a possibility of danger to a person, use the circuit that is not re-driving after power-up. There are concerns of an accident.
- STOP keys are valid only when the function is set.  
Prepare the emergency stop switch separately. There are concerns of an accident.
- Do not set the alarm reset with the operation command together, it will re-start without caution.  
Make sure operation command is off and set the alarm rest.  
There are concerns of an accident.
- Do not put any contacts or sticks inside the inverter while it is on.  
There is a possibility of electric shock and fire.

## General Safety Information

### CAUTION

- The heat sink fins will have a high temperature. Be sure not to touch them.  
There is a risk of burns.
- Low to high speed operation of the inverter can be easily set. Be sure to operate it after checking the tolerance of the motor and machine.  
There are concerns of an accident.
- Install an external braking system if needed.  
There are concerns of an accident.
- If the motor needs to operate at a frequency higher than standard Max Frequency setting (50Hz/60Hz), be sure to check with the manufacturers of both the motor and the machine for their approval.  
There is a concern of machine failure.
- Check the following before and during the test run.  
Was the direction of the motor correct?  
Were the RPM and frequency motor correct?  
Were there any abnormal motor vibrations or noises?
- The AC reactor must be installed when the power is not stable in order to avoid damage to the VFD.
- Do not switch drive inputs when starting or stopping the motor.  
Turning the drive on and off often shortens the life of the drive.  
Damage to the DC bus charging circuit and the DC bus capacitor may result in premature drive failure.  
For maximum performance, the maximum number of charging cycles (i.e. power-up by power supply) of the DC capacitor is:  
Less than five times in ten minutes.

## 4. Maintenance, Inspection and Part Replacement

### CAUTION

- After turning off the input power supply, do not perform the maintenance and inspection for at least 10 minutes.  
There is a possibility of electric shock.
- Make sure that only qualified persons will perform maintenance, inspection and/or part replacement. (Before starting the work, remove metallic objects (wristwatch, bracelet, etc.)  
(Be sure to use insulated tools.)

## 5. Others

### CAUTION

- Never modify the unit.  
There is a possibility of electric shock and accident.

# CONTENTS

<b>1. GENERAL INFORMATION.....</b>	<b>1-1</b>
1.1 Inspection on purchase .....	1-1
1.1.1 Product inspection .....	1-1
1.1.2 Instruction manual.....	1-2
1.2 Inquiry and warranty.....	1-2
1.2.1 Inquiry .....	1-2
1.2.2 Warranty of unit.....	1-2
1.3 Panel view.....	1-3
1.2.3 IMASTER-C1-055LF/075LFP ~ 075LF/110LFP, 055HF/075HFP ~ 075HF/110HFP.....	1-3
1.2.4 IMASTER-C1-110LF/150LFP, 110HF/150HFP ~ 150HF/185HFP.....	1-4
1.2.5 IMASTER-C1-150LF/185LFP, 185HF/220HFP ~ 220HF/300HFP.....	1-5
<b>2. INSTALLATION AND WIRE .....</b>	<b>2-1</b>
2.1 Installation .....	2-1
2.1.1 Precaution .....	2-2
2.2 Wiring .....	2-4
2.2.1 Terminal connection diagram and description .....	2-5
2.2.2 Main circuit terminal description.....	2-6
2.2.3 Main circuit terminal wiring .....	2-7
2.2.4 Control circuit terminal description.....	2-9
2.2.5 Control circuit terminal wiring.....	2-11
2.2.6 Accessory wiring .....	2-15
2.2.7 Torque and wire specification.....	2-17
<b>3. SPECIFICATION.....</b>	<b>3-1</b>
3.1 Specification.....	3-1
3.1.1 200V Class specification .....	3-1
3.1.2 400V Class specification .....	3-1
3.1.3 Performance specification .....	3-2
3.1.4 Braking resistor specification.....	3-4
3.2 Dimension.....	3-5
3.2.1 IMASTER-C1-055LF/075LFP~075LF/110LFP, 055HF/075HFP~075HF/110HFP ....	3-5
3.2.2 IMASTER-C1-110LF/150LFP, 110HF/150HFP~150HF/185HFP .....	3-6
3.2.3 IMASTER-C1-150LF/185LFP, 185HF/220HFP~220HF/300HFP .....	3-7
<b>4. OPERATION .....</b>	<b>4-1</b>
4.1 Keypad overview .....	4-2
4.1.1 Keypad description.....	4-2
4.1.2 Keypad navigation.....	4-3
4.1.3 Shift key function .....	4-7

4.2	Frequency and run sources.....	4-8
4.2.1	Control terminal operation .....	4-8
4.2.2	Digital keypad operation .....	4-8
4.2.3	Combination control terminal and digital keypad.....	4-8
4.2.4	Communication (RS-485) operation.....	4-8
4.3	Test run .....	4-9
4.3.1	To input the operation setting and the frequency setting from the terminal.....	4-9
4.3.2	Operation setting and the frequency setting from the digital operator.....	4-11
<b>5.</b>	<b>PARAMETERS.....</b>	<b>5-1</b>
5.1	Monitoring (d group).....	5-1
5.2	Trip monitor (d group).....	5-1
5.3	Basic function (F group).....	5-2
5.4	Extended function A mode (A group) .....	5-3
5.5	Extended function b mode (b group).....	5-9
5.6	Extended function C mode (C group).....	5-15
5.7	Motor (H group).....	5-19
<b>6.</b>	<b>COMMUNICATION.....</b>	<b>6-1</b>
<b>7.</b>	<b>PROTECTIVE FUNCTION.....</b>	<b>7-1</b>
<b>8.</b>	<b>TROUBLESHOOTING TIPS .....</b>	<b>8-1</b>
<b>9.</b>	<b>MAINTENANCE AND INSPECTION.....</b>	<b>9-1</b>
9.1	General precautions and notes .....	9-1
9.2	Inspection items.....	9-1
9.2	Inverter electrical measurements .....	9-3

# 1. GENERAL INFORMATION

## 1.1 Inspection on purchase

### 1.1.1 Product inspection

Please inspect following before installation.

- (1) No damage made to the unit during transportation?
- (2) One Instruction manual is enclosed?
- (3) Check the label specification if the correct product is delivered per your order.

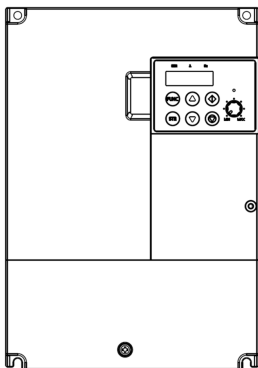

Figure 1-1 Outlook of iMaster C1

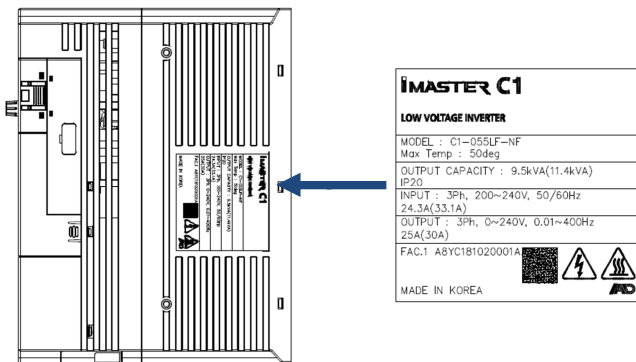

Figure 1-2 iMaster C1 Specification on label

### **1.1.2 Instruction manual**

This instruction manual is for the iMaster C1 series.

Carefully read the manual before operating the inverter and please read this manual and keep it as a reference.

In addition, this manual is intended to be delivered to the final user.

0

## **1.2 Inquiry and warranty**

### **1.2.1 Inquiry**

- If you have any questions about damage to the inverter, unknown parts, or other information, please contact the place of purchase with the following information.

- (1) Product model name
- (2) Manufacturing number (MFG. No.)
- (3) Date of purchase
- (4) Failure details (as detailed as possible)
  - Damaged parts, condition, etc.
  - Unknown parts, condition, etc.

### **1.2.2 Warranty of unit**

- The warranty period for the delivery product is one year after delivery.  
However, the warranty will be void if the fault is due to:
  - (1) In case of unfair treatment and use by the consumer
  - (2) If the cause of failure is due to a reason other than the product supplied
  - (3) When using a product that is out of specification
  - (4) In case the supplier is not responsible for other natural disasters (earthquake, lightning)
- Since the warranty mentioned here means the inverter itself, the damage caused by the inverter failure shall not be liable.
- After warranty period, the entire test or repair will be charged.  
Any failure caused by above mentioned items within the warranty period will be claimed.  
Please contact your place of purchase for any problems that have occurred within the warranty period

### 1.3 Panel view

#### 1.2.3 IMASTER-C1-055LF/075LFP ~ 075LF/110LFP, 055HF/075HFP ~ 075HF/110HFP

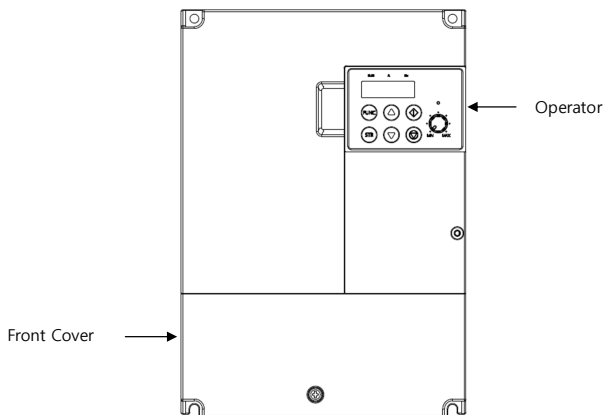

Figure 1-3 Front view with front cover

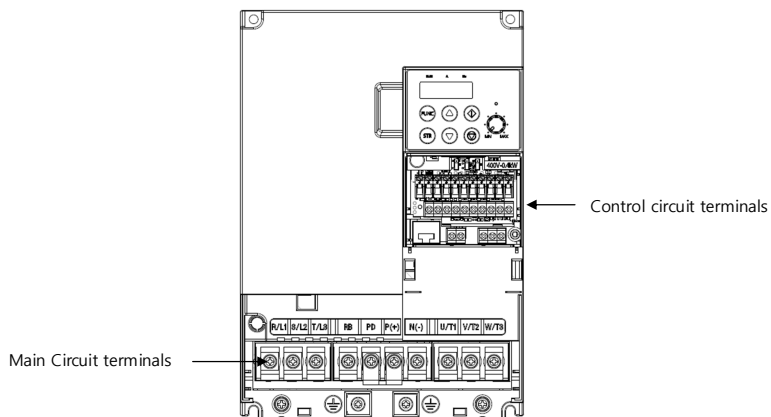

Figure 1-4 Front view without front cover

## 1.2.4 IMASTER-C1-110LF/150LFP, 110HF/150HFP ~ 150HF/185HFP

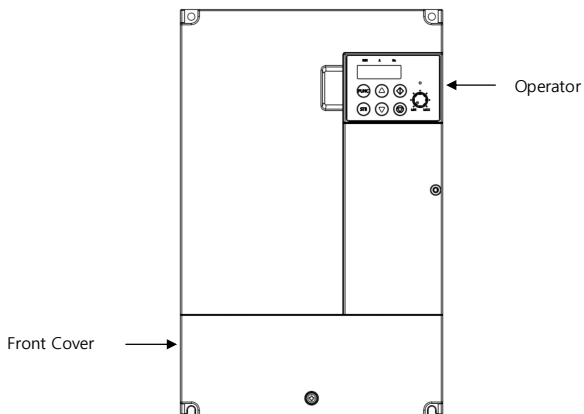

Figure 1-5 Front view with front cover

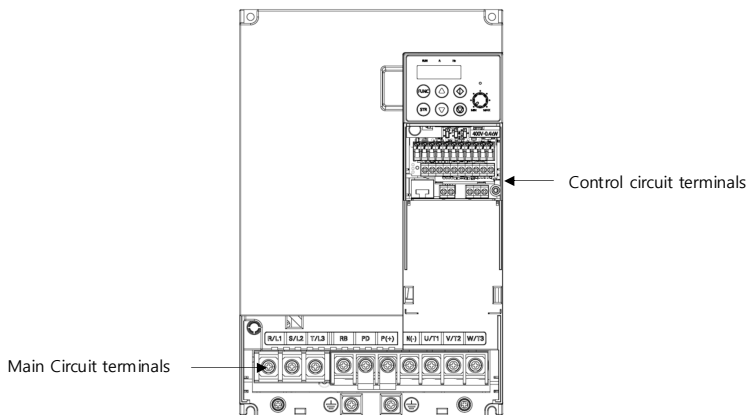

Figure 1-6 Front view without front cover



## 1.2.5 IMASTER-C1-150LF/185LFP, 185HF/220HFP ~ 220HF/300HFP

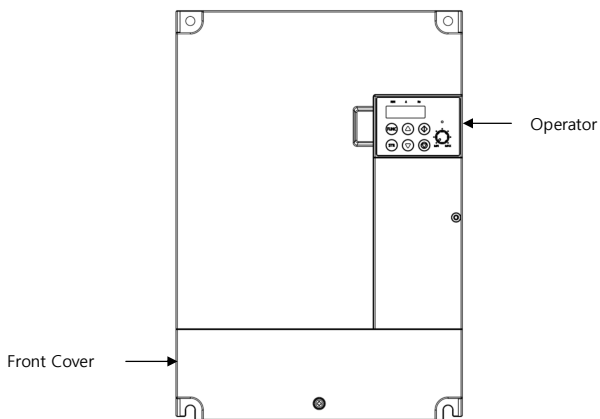

Figure 1-7 Front view with front cover

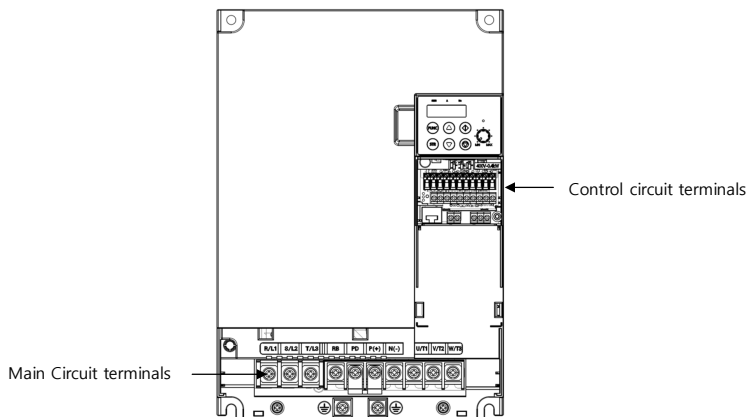

Figure 1-8 Front view without front cover

## 2. INSTALLATION AND WIRE

### 2.1 Installation

 <b>CAUTION</b>
--

- Be sure to install the unit on flame resistant material such as metal.  
There is a fire hazard.
- Be sure not to place anything flammable such as corrosive gas, explosive gas, inflammable gas, grinding fluid mist, salt in the vicinity.
- Do not carry the unit by the top cover, but always by supporting the base of the unit  
There is a possibility of an accident by falling down.
- Be sure not to let foreign matter enter such as cut wire refuse, spatter from welding, iron refuse, wire, dust, etc.
- Be sure to install the VFD in a place which can support the weight according to the specification in the manual.
- Do not install or run the damaged inverter.  
There are concerns of an accident.
- Avoid high temperature, humidity, condensation dust corrosive gas, explosive gas, combustible gas and install the inverter with good ventilation without direct sunlight.  
There is a fire hazard.
- To prevent injury, make sure to wear electric working gloves before working.

### 2.1.1 Precaution

#### (1) Caution in transport

- The inverter uses plastic parts. Care must be taken to avoid damage. In particular, fasten it with designated parts to ensure that it is firmly secured to the wall or panel. Also, do not operate the inverter with damage and loss of parts.

#### (2) Install it on the non-flammable (metal, etc.) surface

- Inverter heat shield temperatures can be very high. As there is a risk of fire, place it on a non-flammable vertical wall (metal, etc.). Attention should also be made to the air gap surrounding the inverter. Especially, when there is a heat source such as a braking resistor or reactor. Keep sufficient space to prevent clogging of cooling ventilation by the up/down wiring.

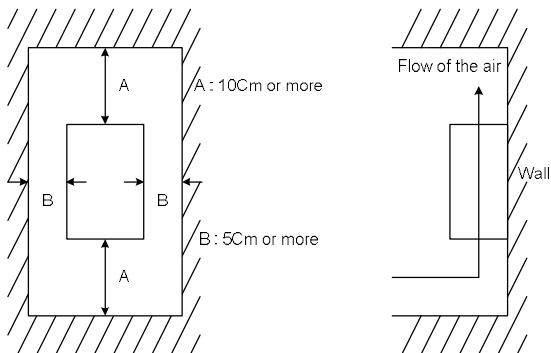

Figure 2-1 Air gap (Installation)

#### (3) Ambient temperature

- The ambient temperature surrounding the inverter should not exceed the allowable temperature range (HD:  $-10$  to  $50^{\circ}\text{C}$ /ND:  $-10$  to  $40^{\circ}\text{C}$ ). Measure the ambient temperature about 5 cm from the bottom center of the inverter body and make sure that it is within the allowable temperature range. If the temperature exceeds the allowable temperature, component life will become shortened especially in the case of the bus capacitors.

#### (4) Humidity

- The humidity surrounding the inverter should be within the limit of the allowable percentage range (20% to 90% / RH).

Under no circumstances should the inverter be in an environment where there is the possibility of moisture entering the inverter.

Also avoid having the inverter mounted in a place that is exposed to the direct sunlight.

#### (5) Caution in the installation

- Please be install the inverter avoid dust, corrosive gases, explosive gases, combustible gases.

**(6) Installation of inverter**

- Mount the inverter in a vertical position using screws or bolts. The mounting surface should also be free from vibration and can easily hold the weight of the inverter.

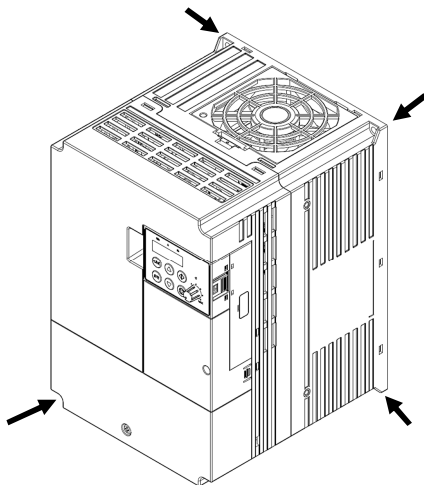
**Figure 2-2 Mounting Position****(7) Ventilation in panel**

- Install a ventilation fan when installing the inverter inside the panel. The position of the inverter cooling fan and air inlet is critical. If the position is incorrect, the air flow around the inverter will decrease and the temperature around the inverter will increase. Make sure that the ambient temperature is within the allowable range.

## 2.2 Wiring



### DANGER

- Be sure to ground the unit.  
There is a possibility of electric shock and fire.
- Wiring work should be carried out by qualified electricians  
There is a possibility of electric shock and fire.
- Implement wiring after checking that the power supply is off.  
There is a possibility of electric shock.
- After mounting the VFD, carry out wiring.  
There is a possibility of electric shock.



### CAUTION

- Make sure that the rated voltage and AC power voltage are same.  
There are concerns of an accident and fire
- Be sure not to connect AC power supply to the output terminals (U, V, W).  
There are concerns of an accident and fire
- Install the short circuit breaker on the input side.  
There is a fire hazard.
- Use rated power lines, short circuit breakers and electronic contactors.  
There is a fire hazard.
- Do not use the electromagnetic contactors on the primary side of the inverter as means of start/stop control.

## 2.2.1 Terminal connection diagram and description

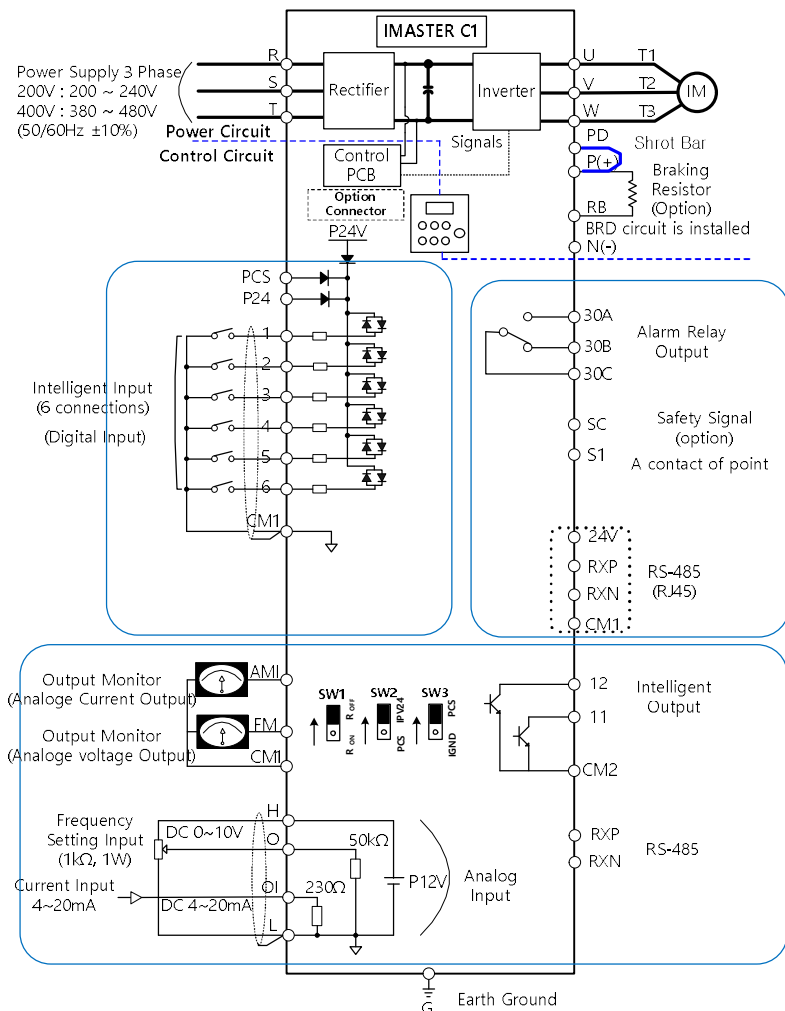

Figure 2-3 Terminal connection diagram (Sink type)

## 2.2.2 Main circuit terminal description

Table 2-1 Main circuit terminal description

Terminal	Terminal Name	Function
R,S,T (L1,L2,L3)	Main power input	AC input power supply
U,V,W (T1,T2,T3)	Inverter output	PWM output power for motor
PD,P (+1,+)	DC Reactor Connection	Remove the shorting bar between PD and P for connection to DC Reactor.
P, RB (+,-)	External Braking Resistance Connection	Optional External Braking Resistor Connector.
P, N	External Braking Unit Connection	Optional External Braking Unit Connector.
G	Inverter ground	Ground Terminal

Table 2-2 Main circuit terminals view

Main circuit terminals										Corresponding type	Screw size	width (mm)
										055LF/075LFP 075LF/110LFP 055HF/075HFP 075HF/110HFP	M4	10.3
R/L1	S/L2	T/L3	RB	PD	P(+)	N(-)	U/T1	V/T2	W/T3	110LF/150LFP 110HF/150HFP 150HF/185HFP	M5	13
										150LF/185LFP 185HF/220HFP 220HF/300HFP	M5	13

Step1) Connecting 3-phase power to the input end of the inverter.

Connect 3-phase power to the inverter power input terminal R(L1), S(L2), T(L3) as table 2-2.

Step2) Connect the inverter to the three-phase motor.

Connect the inverter output stage U(T1), V(T2), W(T3) to the three-phase motor as table 2-2

Step3) The optional direct current reactors are hardwired to the P and PD terminals as shown.

However, remove the shorting bar when connecting the DC reactor.



Do not connect AC power to the output terminals (U,V,W). There is a fire hazard.

### 2.2.3 Main circuit terminal wiring

#### (1) Warning on wiring

When carrying out work on the inverter wiring make sure to wait for at least ten minutes before you remove the cover. Be sure to verify that the charge lamp is not illuminated.

A final check should always be made with a voltage meter.

After removing the power supply, there is a time delay before the capacitors will dissipate their charge.

#### 1) Main power terminals: R(L1), S(L2), T(L3)

- Connect the main power terminals (R(L1), S(L2) and T(L3)) to the power supply through an electromagnetic contactor or an earth-leakage breaker. Use a high harmonic sensitivity current value as the short circuit breaker may malfunction due to harmonic effects. Install an electronic contactor to turn off the inverter power to prevent failure or accident when inverter's protection function is activated.
- This unit is for a three-phase power supply. Be sure not to power a three-phase only inverter with single phase power.
- Do not stop operation by switching off the electromagnetic contactors on the primary or secondary sides of the inverter.
- The inverter enters into the following condition at the occurrence of open phase if it is selected open phase protection is valid: R phase, S phase or T phase, open phase condition:  
It becomes single-phase operation condition. Trip operation, such as a deficiency voltage or over current, may occur.
- A converter module may be damaged as a result of the following conditions. Use caution when,
  - Unbalanced power supply voltage more than 3%
  - Power supply capacity is more than 10 times of the capacity of inverter
  - A drastic change in the power supply
- Turning on/off the power supply more than three times in one minute. Could be damaged.

#### 2) Inverter output terminals: U(T1), V(T2), W(T3)

- Make sure to use a heavier gauge wire when you have long motor leads. This will help to reduce the voltage drop.
- Do not install power factor correction capacitors or a surge absorber to the output of the inverter.  
Inverter will trip or sustain damage to the output transistors.
- In the case of the cable length being more than 20 meters, it is possible that a surge voltage will



be generated and damage to the motor is caused by the floating capacity or the inductance in the wire. When an EMC filter is to be installed, please contact to us.

- In the case of two or more motors, install a thermal relay to each motor.
- Make the RC value of the thermal relay the value of 1.1 times of motor rated electric current

### 3) Direct current reactor (DCL) connection terminals (PD, P)

- These are the terminals to connect the current reactor DCL (optional) to help improve the power factor.

The short bar is connected to the terminals when shipped from the factory, if you are to connect a DCL you will need to disconnect the short bar first.

- The cable length should be less than 5 meters.

### 4) External braking resistor connection terminals (P, RB)

- The regenerative braking circuit (BRD) is built-in as standard.
- When braking is required, install an external braking resistor to these terminals.
- The cable length should be less than 16 feet, and twist the two connecting wires to reduce inductance.
- Do not connect any other device other than the external braking resistor to these terminals. When installing an external braking resistor make sure that the resistance is correctly rated to limit the current drawn through the BRD.

### 5) Earth ground (G)

- Make sure that you securely ground the inverter and motor for prevention of electric shock. The inverter and motor must be connected to an appropriate safety earth ground and follow all local electrical codes.
- In case connecting 2 or more inverters, use caution not to use a loop which can cause some malfunction of the inverter.

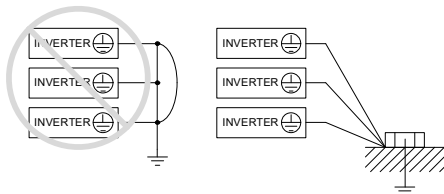

Figure 2-4 Earth Ground (G)

## 2.2.4 Control circuit terminal description

Table 2-3 Control Circuit Terminal Description

Signal	Terminal	Terminal Name	Function
Input signal	P24	Power terminal for input signal	24VDC $\pm$ 15%, 100mA
	PCS	Power supply for external device	DC 27V Max
	6	Intelligent input terminal (C01~C06)	Contact input: Close: ON (Operating) Open: OFF (Stop)  Minimum ON TIME:12ms
	5	Forward run command (FW), Reverse run command (RV), Multi-speed commands1-4(CF1-4),	
	4	2-stage accel/decel (2CH), Reset (RS), Free run stop (FRS), External trip (EXT), Terminal software lock (SFT), Current input selection (AT), Jogging operation (JG),	
	3	Unattended start protection (USP),	
	2	3 wires input (STA,STP,F/R), Up/Down (Up, Down), Local keypad operation(O/R),	
	1	Local terminal input operation(T/R), PID integral reset (PIDIR), PID disable (PIDD)	
CM1	Common terminal for input or monitors signal		
Monitor signal	FM	Analog Monitor (Frequency, Current, Voltage, Power)	0~10Vdc, 1mA
	AMI	Analog Monitor (Frequency, Current, Voltage, Power)	4~20mA, 250 $\Omega$
Frequency command signal	H	Frequency power	10.5VDC
	O	Frequency command power terminal (voltage)	0~10VDC, Input impedance: 50k $\Omega$
	OI	Frequency command terminal (current)	4~20mA, Input impedance: 230 $\Omega$
	L	Analog power common	-
Intelligent relay output signal	30A	Relay output terminal (C13)	AC 250V 2.5A (Resistor load) 0.2A (Inductor load)
	30B	Run status signal (RUN), Frequency arrival signal (FA1), Set frequency arrival signal (FA2),	DC 30V 3.0A (Resistor load) 0.7A (Induction load)
	30C	Overload advance notice signal (OL), PID error deviation signal (OD), Alarm signal (AL)	

Signal	Terminal	Terminal Name	Function
Intelligent output signal	11	Open collector output (C14~C15)	24VDC, 50mA max
	12	Run status signal (RUN), Frequency arrival signal (FA1), Set frequency arrival signal (FA2), Overload advance notice signal (OL), PID error deviation signal (OD), Alarm signal (AL)	
	CM2	Common terminal for output	
1 <sup>st</sup> communication (RJ-45)	RXP	RJ-45 connector no. 3	RS-485 communication terminal
	RXN	RJ-45 connector no. 6	
Safety input signal	SC	Common terminal for safety input	Intelligent input
	S1	Safety A point input	
2 <sup>nd</sup> communication (speed set b31)	RXP	RS-485 (+)	2 <sup>nd</sup> RS-485 communication terminal
	RXN	RS-485 (-)	

## 2.2.5 Control circuit terminal wiring

### (1) Wiring of control circuit terminal

The control circuit terminal of iMaster C1 is as below.

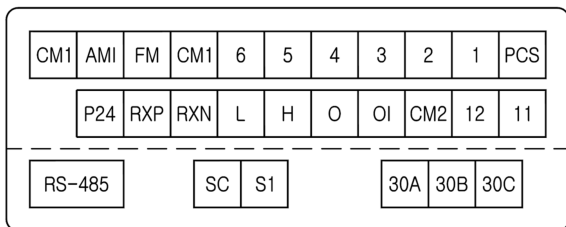

Figure 2-5 Control circuit terminal

### (2) Example of control circuit wiring

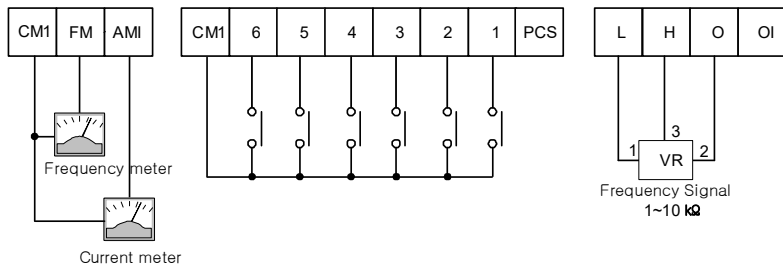
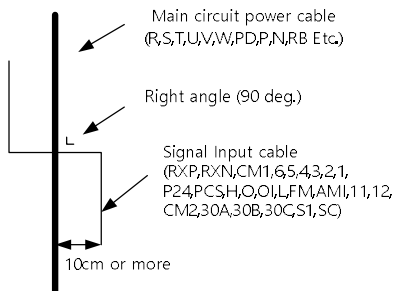

Figure 2-6 Example of control circuit wiring

**(3) Precaution of wiring**

- 1) Control terminals are insulated to its power lines (R, S, T, U, V, W, PD, N, RB).  
Do not connect those terminals to power lines or ground.
- 2) Use twisted screened cable, for the input and output wires of the control circuit terminals.  
Connect the screened cable to the common terminal.
- 3) Limit the connection wires to 20 meters.
- 4) Separate the control circuit wiring from the main power and relay control wiring.  
If it is inevitable to cross, make it orthogonal. There is a concern of inverter malfunction.



**Figure 2-7 Separate of main circuit and control circuit wire**

- 5) When using relays for the FW terminal or an intelligent input terminal use a control relay that is designed to work with 24Vdc.
- 6) When a relay is used as an intelligent output, connect a diode for surge protection parallel to the relay coil.
- 7) Do not short the analog voltage terminals H and L or the internal power terminals P24 and all CM1's. Otherwise there is risk of Inverter damage.

**(4) Selection the switches**

## 1) RS-485-line termination resistor

Line termination resistor is used to decrease delay of distortion and attenuation at the long distance. It inserts one on the line termination. line termination resistor of inverter is build-in and it can be selected by SW1 switch.

<Line termination resistor switch selection >

SW1: Default value is OFF

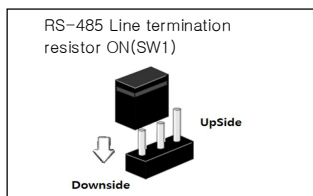
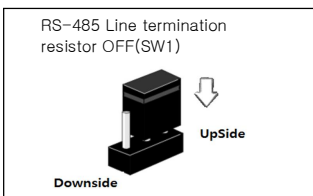
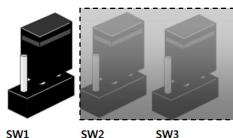

## 2) Connections between Relay output and PLC

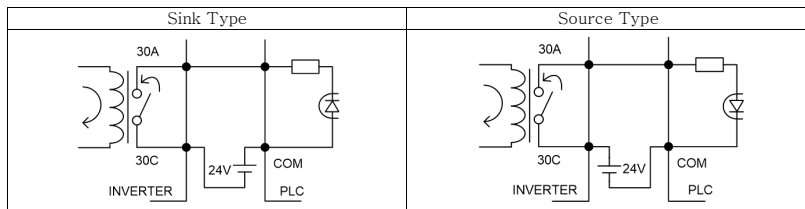
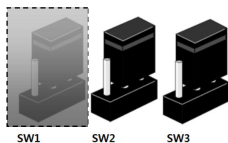

Figure 2-8 Connections between Relay and PLC

## 3) Connection between Input terminal and PLC: Factory setting is Sink type mode

- SW2: Power Source switch for Internal 24V (factory setting) or external PCS input
- SW3: Select switch for Sink type mode (factory setting) and Source type mode



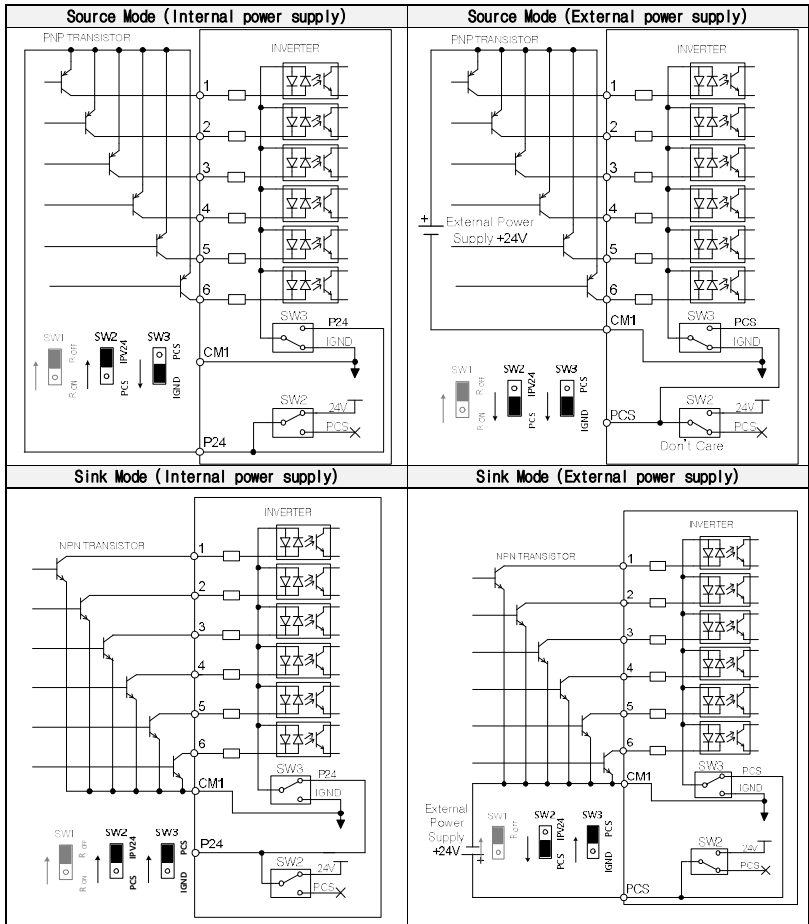
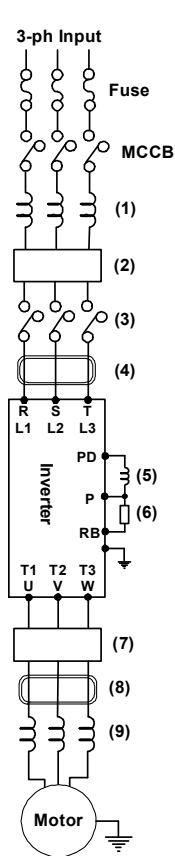

Figure 2-9 Input Terminal and PLC Connection Diagram

## 2.2.6 Accessory wiring



Note1: The applicable equipment is for HYUNDAI standard four pole squirrel cage motor.

Note2: Be sure to consider the capacity of the circuit breaker to be used.

Note3: Be sure to use larger wire for power lines if the distance exceeds 20m.

Note4: Be sure to use MCCB for the safety.

Note5: Do not operate the electronic contactor when the inverter is running.

Note6: Use 0.75mm<sup>2</sup> for AL relay and RN relay. Separate by the sum (wiring distance from inverter to power supply, from inverter to motor) for the sensitive current of leakage breaker (MCCB).

Note7: When using CV line and wiring by rigid metal conduit, leak flows

Wiring distance	Sensitive current(mA)
100m and less	50mA
300m and less	100mA

Note8: IV line is high dielectric constant that is why the current will be increased 8 times. Therefore, use the sensitive current 8 times as large as that of the left list.

And if the distance of wire is over 100m, use CV line.

Note9: Do not stop operation by switching off the electromagnetic contactors. If you need to use electromagnetic contactors for predation because of bypass operation, be sure the protective circuit must be configured so that it cannot be switched on or off during inverter operation.

Figure 2-10  
Example of accessories connection



Table 2-4 Optional accessories for improved performance

Name		Function
(1)	Input AC Reactor	Recommended to use when the unbalance voltage rate is 3% or more and power supply is 500 kVA or more, and there is a rapid change in the power supply. It also reduces harmonics and improves the power factor.
(2)	Noise filter for Inverter	Reduces common noise generated between the power supply and the ground, as well as normal noise. Put it in the primary side of inverter.
(3)	Radio Noise Filter (zero-phase reactor)	Helps to reduce noise on a peripheral radio when an inverter is running.
(4)	Input Radio Noise Filter	Reduces radiation noise emitted from wire at the input.
(5)	DC Reactor	Helps to improve power factor for the inverter.
(6)	Breaking Resistor/Regenerative Breaking Unit	Used for applications that need to increase the brake torque of the inverter or to frequently start/stop and to run high inertia load.
(7)	Output Noise Filter	Reduces noise emitted from the inverter motor leads. This helps to minimize interference with sensitive equipment (i.e.: sensors or weight scale).
(8)	Radio Noise Filter (Zero-phase reactor)	Reduces noise generated at the output of the inverter. (It is possible to use for both input and output.)
(9)	Output alternation reactor Reducing vibration, thermal Relay, preventing Misapplication	Running motors with the inverter generates vibration greater than that with commercial power supply. This part installed between the inverter and motor reduces torque ripple. When the cable length between the inverter and motor is long (10m or more), a countermeasure for a malfunction of the thermal relay by harmonic due to switching on inverter is taken by inserting reactor. There is the way to use current sensor instead of thermal relay.
	LCR filter	Sine-wave filter for output

## 2.2.7 Torque and wire specification

Table 2-5 Applicable tools for N700E (Heavy duty)

Class	Motor Output (kW)	Inverter model (IMASTER-C1)	Power lines <sup>note1</sup> R,S,T, U,V,W,PD,P	External resistor between P and RB	Screw size of Terminal	Torque (N·m)	Applicable Tools		
							Leak breaker (MCCB)		Electro-magnetic Controller (MC)
200V Class	5.5	055LF/075LFP	More than 6	6	M4	1.2	UCB100R	50A	HIMC32
	7.5	075LF/110LFP	More than 10	6	M4	1.2	UCB100R	50A	HIMC32
	11	110LF/150LFP	More than 16	6	M5	3.0	UCB100R	75A	HIMC50
	15	150LF/185LFP	More than 25	16	M5	3.0	UCB100R	100A	HIMC65
400V Class	5.5	055HF/075HFP	More than 4	4	M4	1.2	UAB30C	30A	HIMC18
	7.5	075HF/110HFP	More than 4	4	M4	1.2	UAB30C	30A	HIMC18
	11	110HF/150HFP	More than 6	6	M4	1.2	UCB100R	50A	HIMC32
	15	150HF/185HFP	More than 10	10	M5	3.0	UCB100R	50A	HIMC40
	18.5	185HF/220HFP	More than 16	10	M5	3.0	UCB100R	75A	HIMC40
	22	220HF/300HFP	More than 25	10	M5	3.0	UCB100R	75A	HIMC50

Note 1) Use a 600V, 75°C copper wire for wires.

Table 2-6 Applicable tools for N700E P-TYPE (Normal duty)

Class	Motor Output (kW)	Inverter model (IMASTER-C1)	Power lines <sup>note1</sup> R,S,T, U,V,W,PD,P	External resistor between P and RB	Screw size of Terminal	Torque (N·m)	Applicable Tools		
							Leak breaker (MCCB)		Leak breaker (MCCB)
200V Class	7.5	055LF/075LFP	More than 10	6	M4	1.2	UCB100R	50A	HIMC32
	11	075LF/110LFP	More than 16	6	M5	3.0	UCB100R	75A	HIMC50
	15	110LF/150LFP	More than 25	16	M5	3.0	UCB100R	100A	HIMC65
	18.5	150LF/185LFP	More than 30	16	M6	4.5	UCB250S	150A	HIMC80
400V Class	7.5	055HF/075HFP	More than 4	4	M4	1.2	UAB30C	30A	HIMC18
	11	075HF/110HFP	More than 6	6	M4	1.2	UCB100R	50A	HIMC32
	15	110HF/150HFP	More than 10	10	M5	3.0	UCB100R	50A	HIMC40
	18.5	150HF/185HFP	More than 16	10	M5	3.0	UCB100R	75A	HIMC40
	22	185HF/220HFP	More than 25	10	M5	3.0	UCB100R	75A	HIMC50
	30	220HF/300HFP	More than 25	-	M6	4.5	UCB100R	100A	HIMC65

Note 1) Use a 600V, 75°C copper wire for wires.

### 3. SPECIFICATION

#### 3.1 Specification

##### 3.1.1 200V Class specification

Inverter model		055LF/ 075LFP	075LF/ 110LFP	110LF/ 150LFP	150LF/ 185LFP	
Applicable motor (4P, kW) <sup>(Note1)</sup>	HD	5.5	7.5	11	15	
	ND	7.5	11	15	18.5	
Rated capacity (kVA)	HD	200V	8.3	11.1	15.6	22.2
		240V	10.0	13.3	18.7	26.6
	ND	200V	10.4	15.2	20.0	25.2
		240V	12.5	18.2	24.1	30.3
Rated input voltage		Three Phase 200 ~ 240 V +/- 10 %, 50/60 Hz +/- 5%				
Rated output voltage <sup>(Note2)</sup>		Three Phase 200 ~ 240 V (Corresponding to Input Voltage)				
Rated output current (A)	HD	25	33	47	64	
	ND	30	40	56	73	
Weight (Kg)		4.2	4.5	4.5	6.5	
Protection Design		IP20				

##### 3.1.2 400V Class specification

Inverter model		055HF/ 075HFP	075HF/ 110HFP	110HF/ 150HFP	150HF/ 185HFP	185HF/ 220HFP	220HF/ 300HFP	
Applicable motor (4P, kW) <sup>(Note1)</sup>	HD	5.5	7.5	11	15	18.5	22	
	ND	7.5	11	15	18.5	22	30	
Rated capacity (kVA)	HD	380V	7.9	10.5	15.1	21.1	25.0	29.6
		480V	10.0	13.3	19.1	26.6	31.6	37.4
	ND	380V	10.4	15.2	20.0	25.6	29.7	39.4
		480V	12.5	18.2	24.1	30.7	35.7	47.3
Rated input voltage		Three Phase 380 ~ 480 V +/- 10 %, 50/60 Hz +/- 5%						
Rated output voltage <sup>(Note2)</sup>		Three Phase 380 ~ 480 V (Corresponding to Input Voltage)						
Rated output current(A)	HD	14.8	18	24	32	39	45	
	ND	17.5	23	31	38	44	58	
Weight (Kg)		4.2	4.5	4.5	7	7	7.5	
Protection Design		IP20						

Note 1: The applicable motor refers to HYUNDAI standard 3-phase motor (4-pole).

To use other motors, care must be taken to prevent the rated motor current (50/60Hz) from exceeding the rated output current of the inverter.

Note 2: The output voltage decreases as the main supply voltage decreases (except for use of the AVR function).

In any case, the output voltage cannot exceed the input power supply voltage.

## 3.1.3 Performance specification

Features		Performance specification
Control method <sup>(Note3)</sup>		Space vector PWM
Output frequency range <sup>(note4)</sup>		0.01~400Hz (Sensorless Vector Control: 0.5 ~ 300Hz)
Frequency accuracy <sup>(Note5)</sup>		Digital command $\pm 0.01\%$ of Max Frequency / Analog Frequency $\pm 0.1\%$
Frequency resolution		Digital setting: 0.01Hz (Under 100Hz), 0.1Hz (Over 100Hz) Analog setting: Max. frequency 500(DC5V), Max. setting frequency 1000 (DC 0 ~ 10V, 4~20mA)
Voltage/frequency characteristic		Base Frequency 0~400Hz setting
Overload current rate		Heavy Duty (150%, 60sec), Normal Duty (120%, 60sec)
Acceleration/deceleration		0.0~6,000 sec (Linear, S curve, U curve) Second acc/dcc can be set
DC injection braking		Operation level and time can be set when above the minimum frequency and below the braking set frequency
I n p u t	Frequency	Operator external signal Set by Keypad (Potentiometer or Arrow Keys) Variable resistance 1W, 1k $\Omega$ ~10k $\Omega$ DC 0~10V (Input impedance 10k $\Omega$ ), DC 4~20mA (Input impedance 200 $\Omega$ )
	Run/Stop	Operator external signal Run/Stop key Forward run/stop Reverse operation/stop is possible for terminal assignment (select 1a, 1b)
	Intelligent input terminal	FW (Forward Run), RV (Reverse Run), CF1~4(Multi-speed Inputs 1~4), RS(Reset), AT (Analog input current/voltage selection signal), USP (Unattended Start Protection), EXT (External trip), FRS (Free-Run Stop), JG(Jogging), SFT (software lock), 2CH (2nd Acceleration / Deceleration), STA, STP, F/R, UP, DOWN(Up/down), UP/DOWN initial value clear O/R (Local Keypad Operation), T/R (Local Terminal Input Operation), PIDR (PID Integral Reset), PIDD (PID Disabled)
O u t p u t	Intelligent output terminal (11-CM2, 12-CM2)	RUN (Run Status Signal), FA1 (Frequency Arrival Signal 1), FA2 (Frequency Arrival Signal 2), OL (Overload Alarm), OD (PID Error Deviation Signal), AL (Alarm signal)
	Alarm relay output terminal	
	FM output	Analog output meter (DC0~10V full scale. Max · 1mA) Output Frequency, Output Current, Output Voltage, Output Power, Output Torque, Operation by Communication
	AMI output	Analog output meter (4~20mA full scale. Max · 250 $\Omega$ ) Output Frequency, Output Current, Output Voltage, Output Power, Output Torque, Operation by Communication

항목		사양
Application specification functions		Auto tuning, AVR function, V/F characteristic selection, Curved acceleration/deceleration, Upper and lower limiters, 16-stage speed profile, Fine adjustment of start frequency, Carrier frequency change (0.5~16kHz), PID, Frequency jump, Gain and Bias setting, Jogging, Electronic thermal level adjustment, Retry function, Automatic torque boost, Trip history monitor, Software lock, S-curved acc/dcc, Frequency conversion display, UPS, IOLT protection, Flying start, BRD
Protection functions		Over current, Over voltage, Communication error, Under voltage, Output short circuit detection, UPS error, EEPROM error, External trip1~6, Ground fault, Over temperature, Input phase loss, Overload, Inverter overload, Braking resistor overload, CPU error, Safety function, HW trip 1~2, Option trip 1~2, OVS fail, Fan fault
E n v i r o m e n t	Ambient temperature	-10~50°C (ND: 40°C)
	Storage temperature	-20~60°C
	Ambient humidity	Below 90%RH (Installed with no dew condensation)
	Vibration	5.9m/s <sup>2</sup> (0.6G), 10~55Hz
	Location	Under 1000m above sea level, indoors (Installed away from corrosive gasses dust)
Option		Noise filter, DC reactor, AC reactor Remote operator, cable for remote operator, Braking resistor <sup>(Note6)</sup>

(Note3) Control method setting A31 to 2 (sensorless vector control) Selected, set carrier frequency more than 2.1kHz.

Sensorless vector performance will be reduced when using a motor less than half of the rated capacity of the inverter.

Multiple motors cannot be driven by sensorless vector control.

(Note4) To operate the motor over 50/60Hz, consult the motor manufacturer about the maximum allowable rotation speed.

(Note5) For motor stabilization control, the output frequency can exceed the maximum frequency set in [A04] up to 1.5 Hz.

(Note6) The inverter also has a regenerative braking circuit built in. However, if a large regenerative torque is required, use the optional braking resistance.

**3.1.4 Braking resistor specification**

- Resistor values in below table are calculated on the basis of 150% rated braking torque, 5% ED<sup>(Note1)</sup>
- Wattage rating of resistor should be doubled for 10% ED.

Recommended DB Resistors for the Rated Inverter Capacity (5% ED<sup>(Note1)</sup>)

Inverter capacity	Ohm [ $\Omega$ ]	Wattage [W] <sup>(Note2)</sup>
055LF/075LFP	17	1000
075LF/110LFP	17	1000
110LF/150LFP	17	1000
150LF/185LFP	8,7	2500
055HF/075HFP	70	1200
075HF/110HFP	50	1200
110HF/150HFP	50	2000
150HF/185HFP	40	2500
185HF/220HFP	20	3000
220HF/300HFP	20	4000

(Note1) ED is duty cycle, 100sec based (5%ED = 5sec)

(Note2) In case of self-cooled DB

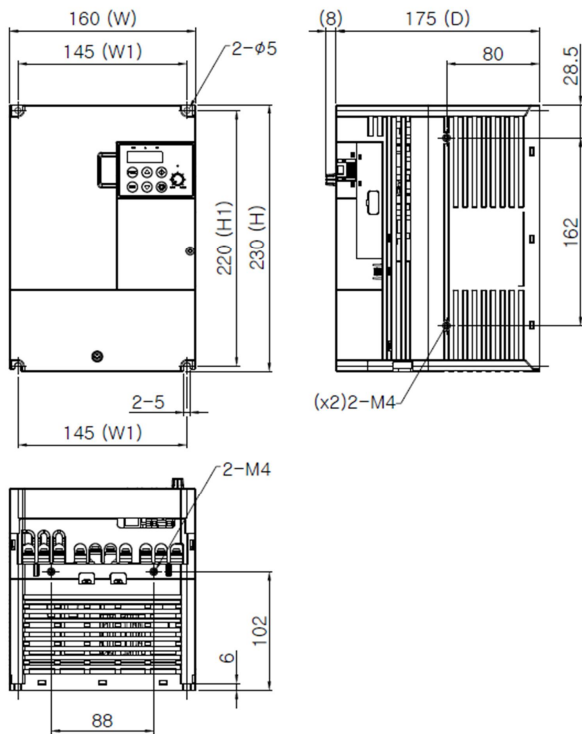
**iMaster-C1 MANUAL****3.2 Dimension****3.2.1 IMASTER-C1-055LF/075LFP~075LF/110LFP,  
055HF/075HFP~075HF/110HFP****iMaster C1-1Frame Diemnsions**

Model	W [mm]	W1 [mm]	H [mm]	H1 [mm]	D [mm]	$\phi$ [mm]	Weight [kg]
055LF/075LFP	160	145	230	220	175	5	2.6
075LF/110LFP	160	145	230	220	175	5	2.6
055HF/075HFP(FLT)	160	145	230	220	175	5	2.5(2.8)
075HF/110HFP(FLT)	160	145	230	220	175	5	2.5(2.8)

## 3.2.2 IMASTER-C1-110LF/150LFP, 110HF/150HFP~150HF/185HFP

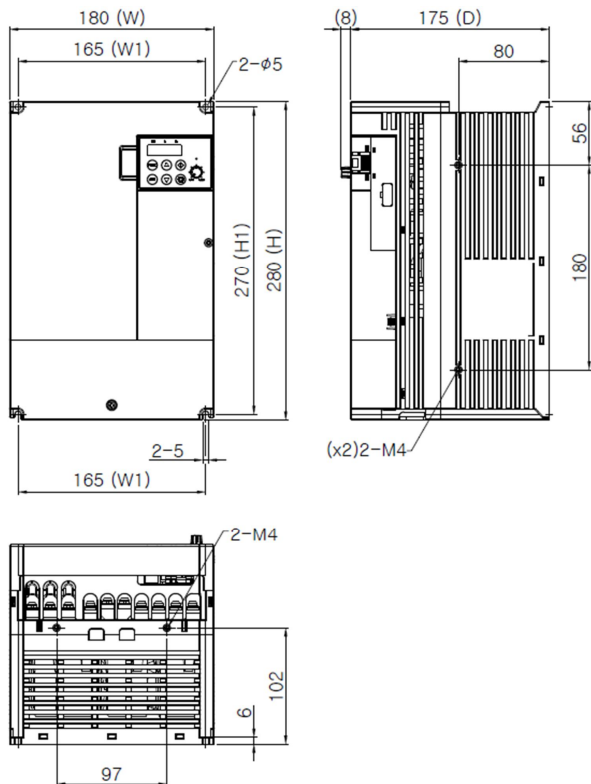

iMaster C1-2Frame Diemsons

Model	W [mm]	W1 [mm]	H [mm]	H1 [mm]	D [mm]	$\phi$ [mm]	Weight [kg]
110LF/150LFP	180	165	280	270	175	5	3.8
110HF/150HFP(FLT)	180	165	280	270	175	5	3.9(4.1)
150HF/185HFP(FLT)	180	165	280	270	175	5	3.9(4.1)



## 3.2.3 IMASTER-C1-150LF/185LFP, 185HF/220HFP~220HF/300HFP

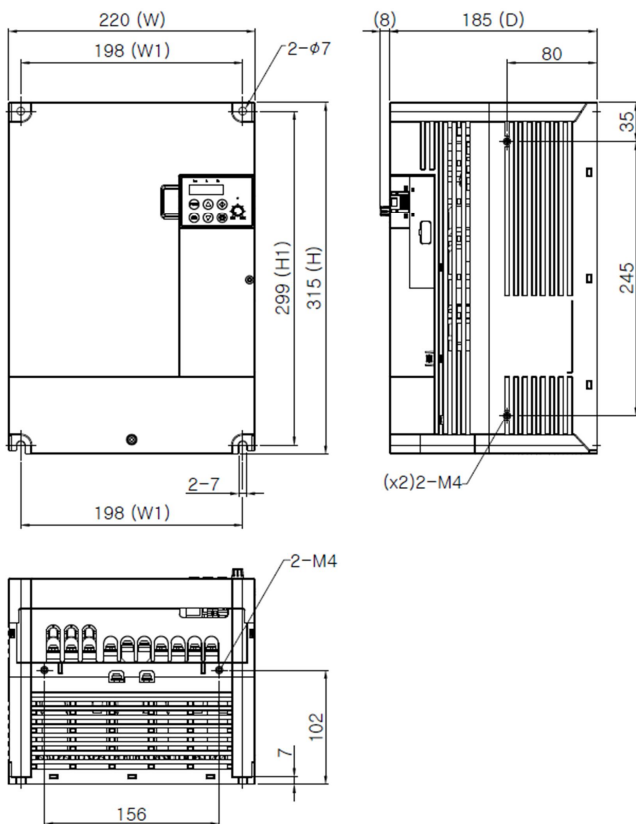

iMaster C1-3Frame Diemsons

Model	W [mm]	W1 [mm]	H [mm]	H1 [mm]	D [mm]	$\phi$ [mm]	Weight [kg]
150LF/185LFP	220	198	315	299	185	7	5.5
185HF/220HFP(FLT)	220	198	315	299	185	7	5.8(6.1)
220HF/300HFP(FLT)	220	198	315	299	185	7	5.8(6.1)

## 4. OPERATION

 **DANGER**

- Be sure not to touch the main terminal or to check the signal add or remove wires and/or connectors.
- Be sure not to turn the input power supply on until after front case is closed.  
While the inverter is energized, be sure not to remove the front cover.
- Be sure not to operate the switches with wet hands.
- While the inverter is energized, be sure not to touch the inverter terminals even while the unit is not running.
- If the retry mode is selected, it may suddenly restart during the trip stop.  
Be sure not to approach the equipment. (Be sure) to design the equipment so that personnel safety will be secured even if equipment restarts.
- Even if the power supply is cut for a short period of time, the inverter may restart operation after the power supply is restored if the operation command is given.  
If a restart may incur danger to personnel, be sure to make a circuit so that it will not restart after power recovery.
- The stop key is valid only when a function is on. Ensure that there is a hardware emergency stop that is separate from the stop key of the inverter.
- With the operation command on, if the alarm reset is ordered, the inverter can restart suddenly. Be sure to set the alarm reset after checking the operation command is off.
- Be sure not to touch the inside of the energized inverter or to put a bar into it.

 **CAUTION**

- The cooling fins will have high temperature. Be sure not to touch them.
- Low to high speed operation of the inverter can be easily set. Be sure to operate it after checking the tolerance of the motor and machine.
- Install an external braking system if needed.
- If a motor is operated at a frequency higher than standard setting value(50Hz/60Hz), be sure to check the speeds of the motor and the machine from their manufacturers.  
After getting their consent, operate them.

## 4.1 Keypad overview

iMaster C1 inverter's digital operator is LED type. Please use attached LED operator for running.

### 4.1.1 Keypad description

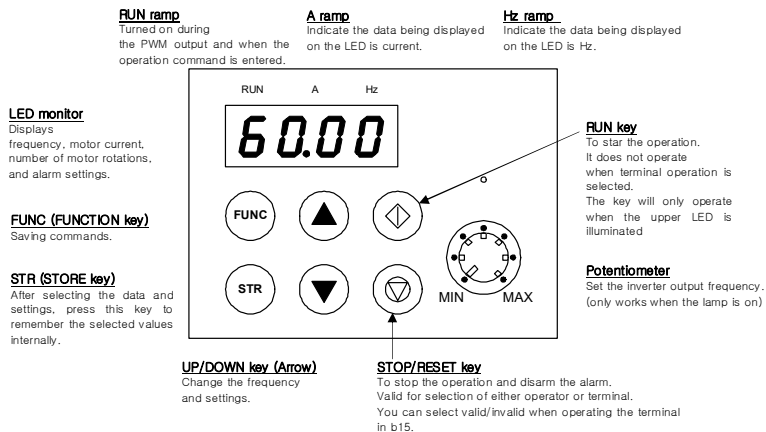

Figure 4-1 LED Keypad description







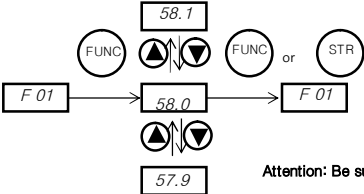

#### Initial keypad display description

Default mode of keypad display is d01 – output frequency of inverter.  
Enter b30, you can set the mode of display: d01~d13.

## 4.1.2 Keypad navigation

## 1) Keypad navigation

Table 4-1 Keypad navigation

Key	Function description
 FUNC	<p>[FUNC(FUNCTION key)] . . . . Use to switch mode to command saving, data setting, extension function and default mode. Pressing this key will change the display to the following at any time.</p>  <p>Attention: Be sure press  for saving.</p>
 RUN	<p>[RUN key] . . . . . It executes the inverter to running.   determines a forward run or reverse run.</p>
 STOP/ RESET	<p>[STOP/RESET key] . . . . It executes the inverter to stop.            For trips, it reset the inverter.</p>
  	<p>[UP key, DOWN key] . . . .Select the value of setting or command by moving key.</p>

## ※ Attention for STR key

If you want to store the data using STR key, please stay at least 6sec without any change or moving up/down key.

If you change anything such as key operations, reset operations, and power down before 6 seconds, the correct data may not be stored.

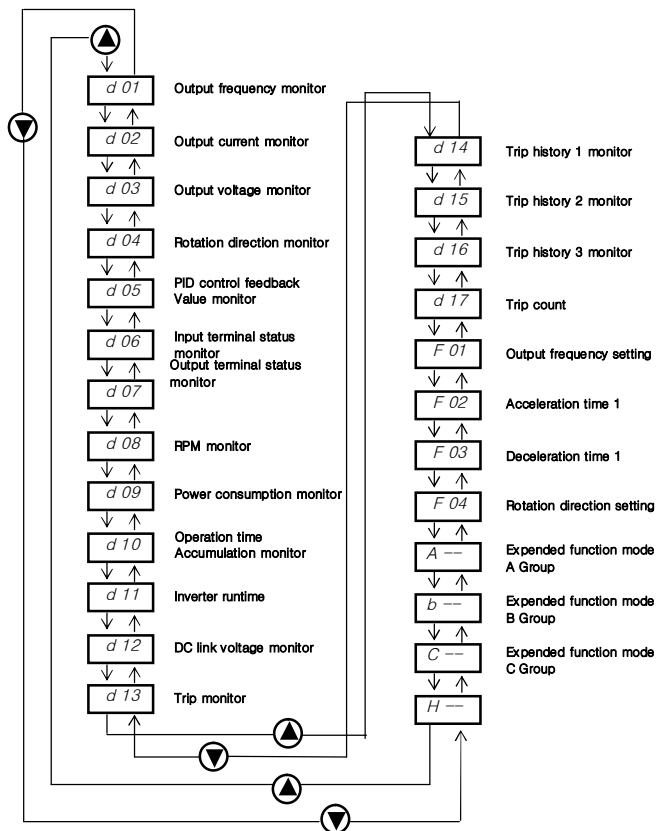

Figure 4-2 Up/Down key basic operation

## 2) Expanded function mode navigation

Using the ▲ / ▼ key to enter the expanded function mode, select expanded Function command NO. in **A--**, **b--**, **C--** and **H--** mode.

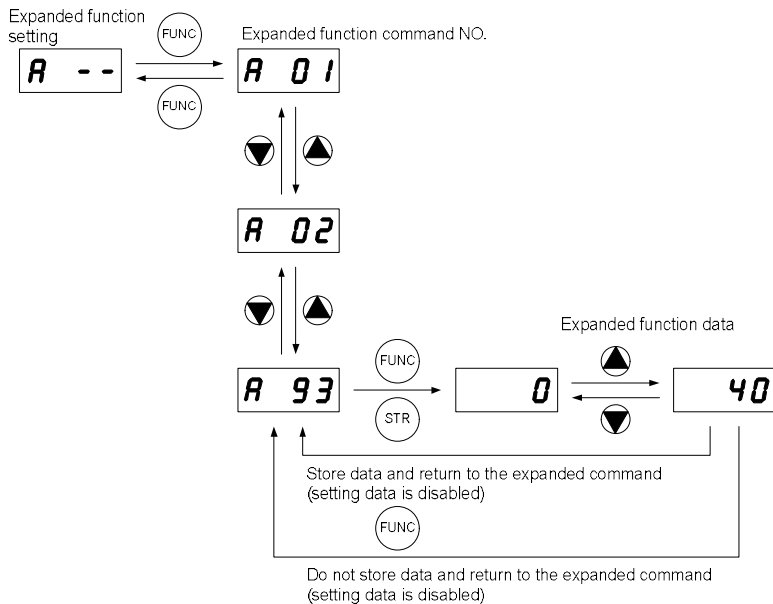

Figure 4-3 Expanded function mode navigation

## 3) Navigation example: Mode change with arrow keypad

(Change the way of frequency setting from potentiometer to up/down key.  
Running the inverter by up/down key operation)

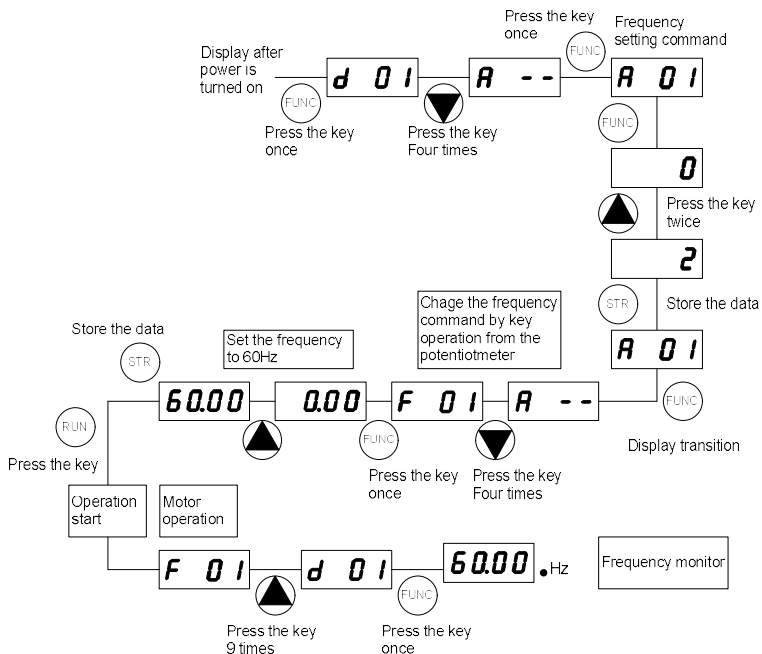

Figure 4-4 Navigation example: Mode change with arrow keypad

### 4.1.3 Shift key function

The "SHIFT" function is enabled to press both up and down key simultaneously. The left segment digit is blinked and if press store key, the blinked segment moves to the right digit.

When the 'store' key is pressed, it moved to the right digits again.

When the right most digit is blinked and press the 'store' key, it turned back to the function code display.

#### 1. Display digit movement

- Press the UP key and Down key at the same time in data setting mode.
- Change scroll mode to shift mode.

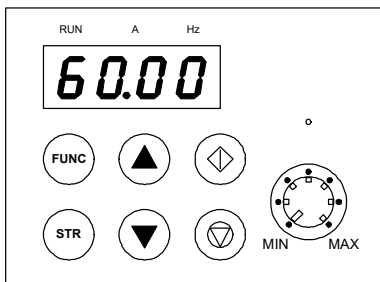

Figure 4-5 How to use Shift key

#### 2. Data setting method

Stop in target group using UP/DOWN key → Press the function key, Change to data setting mode.

- 1) Press the UP key and DOWN key at the same time. → First number is flashing on the left
- 2) Change the data using UP/DOWN key → Press the Store-key → Third number is flashing.
- 3) Change the data using UP/DOWN key → Press the Store-key → Second number is flashing
- 4) Change the data using UP/DOWN key → Press the Store-key → First number is flashing
- 5) Change the data using UP/DOWN key → Press the Store-key → Target function code is setting



## 4.2 Frequency and run sources

In order to run the inverter, the run command source and frequency command source must be determined. Select one frequency command source and one run command source from list below and follow the instruction in the section referenced

### 4.2.1 Control terminal operation

Connect external signal to control terminal then running the inverter with this signal. Start operation by operation command (FW, RV) after inverter turning on. However, there are 2 ways for setting the terminal frequency – run or frequency command, please select for each system.

For detailed specifications, refer to the control circuit terminal description (required for operation)

- 1) Run command: The inverter is run/stop by external signal inputs such as switches and relays. (Please refer 4-3)
- 2) Frequency command: Operating frequency is determined external signals 0 to 10V or 4 to 20mA. (Please refer 4-3)

### 4.2.2 Digital keypad operation

Operation the inverter with mounted keypad – arrow key and potentiometer.

<Operation navigation>

1. Set frequency command source to potentiometer (A01=0)
2. Set run command source to standard operator (A02=0)
3. Press RUN button on the mounted operator, inverter will be run.
4. Change frequency using potentiometer.  
(If set A01=2, can change frequency with up/down key ▲▼.)

### 4.2.3 Combination control terminal and digital keypad

Operation the inverter with combined way.

You can select the way of setting for frequency command and run command each.

### 4.2.4 Communication (RS-485) operation

The inverter can be driven by a communication command from an external control device, such as a PLC. You can also control the inverter through the optional Remote Operator (ROP).

See '6. Communication Functions' for details.

### 4.3 Test run

This is an example of a common connection. If you prefer to use digital operator, please refer to detailed use of the digital operator.

#### 4.3.1 To input the operation setting and the frequency setting from the terminal

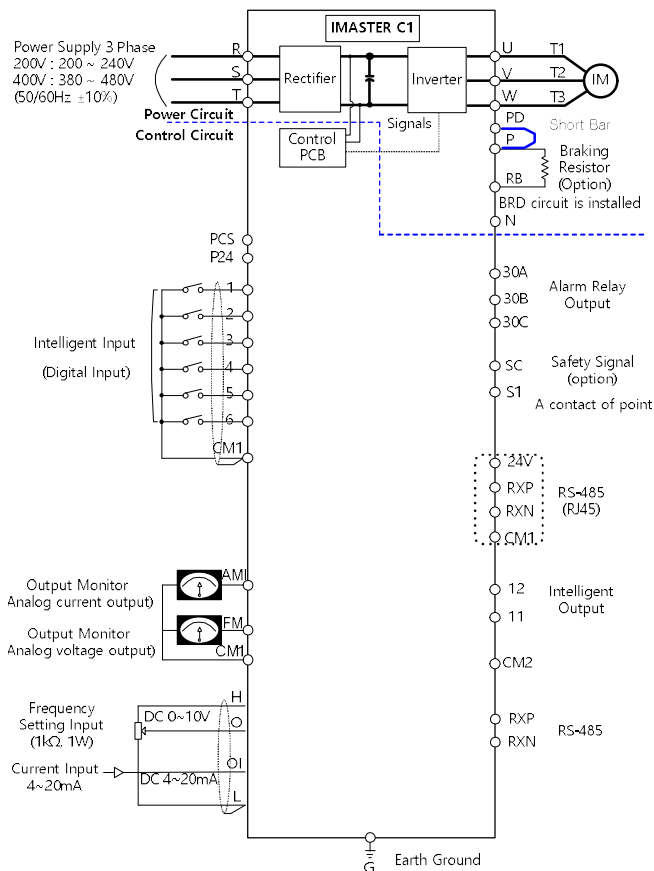

Figure 4-6 Setting diagram from the terminal

## &lt;Procedure&gt;

**(1) Please make sure that the connections are secured correctly.**

- Connect the power supply to R(L1), S(L2), T(L3)
- Connect the motor to U(T1), V(T2), W(T3)

**(2) Turn on power supply to the inverter**

- Please make sure the operator should illuminate.

**(3) Set the terminal with the frequency setting selection.**

- Set A01 as the indication code, press the **FUNC** once. (Code values are shown)
- Set 1 with **A**, press the **STR** once to set the operation setting for the operator.  
(Indication code turns back to A01)

**(4) Set terminal with the operation setting selection.**

- Set A02 as indication code, press the **FUNC** once.
- Set 1 with the **△ V** key, press the **STR** key once to set the operation setting for the operator.  
(Indication code turns back to A02.)

**(5) Set monitor mode**

- When monitoring the output frequency, set indication code to d01.  
Or when monitoring the operation direction, set indication code to d04.

**(6) Input start operation setting**

- Turn on between [FW] and [CM1] of terminal.  
(Run command to the inverter)
- Apply voltage [O] and [L] of terminal to start operation.  
(Frequency command to the inverter)

**(7) Input stop operation setting.**

- Turn OFF between [FW (1)] and [CM1] to slowly stop.

## 4.3.2 Operation setting and the frequency setting from the digital operator

(Remote operator is also same use.)

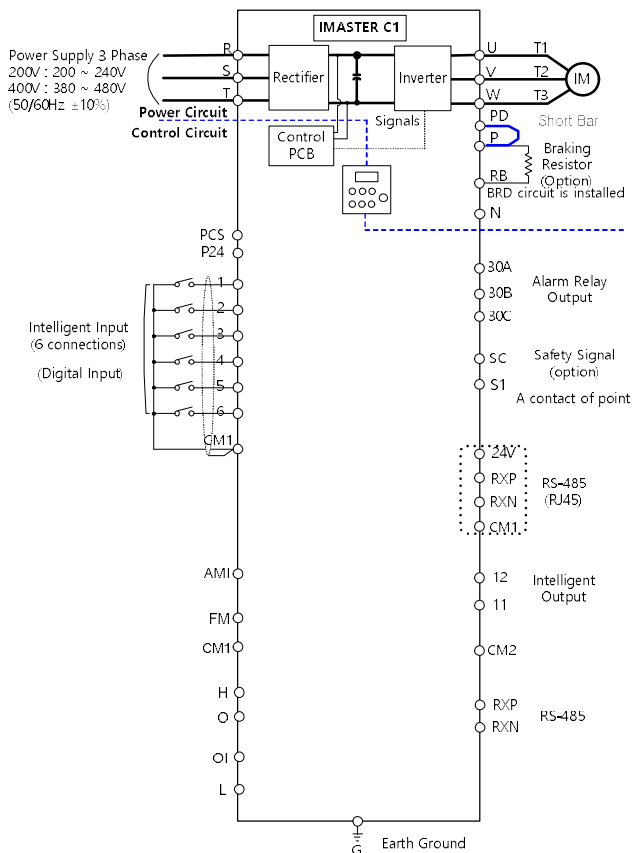

Figure 4-7 Setting diagram from the digital operator

## &lt;Procedure&gt;

**(1) Please make sure that the connections are secured correctly.**

- Connect the power supply to R(L1), S(L2), T(L3)
- Connect the motor to U(T1), V(T2), W(T3)

**(2) Turn on power supply to the inverter.**

- Please make sure the operator should illuminate.

**(3) Set the operator with the frequency setting selection.**

- Set A01 as indication code, press the **FUNC** key once. (Code values are shown.)
- Set 2 with **▲** key (In case of remote is 3), press **STR** key once to set the operation setting for the operator. (Indication code turns back to A01.)

**(4) Set the operator with the operation setting selection.**

- Set A02 as the indication code, and set 2. Press **STR** key to set the operation setting.

**(5) Set the output frequency.**

- Set F01 as indication code, and pressing **FUNC** key once. (Code values are shown.)
- Set to the desired output frequency with **▲**, **▼** key, press **STR** key once to store it.

**(6) Set Monitor mode.**

- When monitoring the output frequency, set indication code to d01.  
Or when monitoring the operation direction, set indication code to d04.

**(7) Press the **RUN** key to start operating.**

- "Run" lamp turns on a light.

**(8) Press the **STOP** key to decelerate to a stop.**

- When the frequency returns to 0, the RUN lamp light will switch off.

- Check whether there is no trip, number of turns, and frequency meter are correct during operation.
- Set the accel/decel time longer, when an over-current trip or over-voltage trip occurs.

## 5. PARAMETERS

### 5.1 Monitoring (d group)

Table 5-1 Monitor mode (d group)

Func-code	Name	Description
d01	Output frequency monitor	Display of output frequency
d02	Output current monitor	Display of output current
d03	Output voltage monitor	Display of output voltage
d04	DC link voltage	Display of DC link voltage
d05	Rotation direction monitor	Display of direction of operation
d06	PID feedback monitor	Displays the scaled PID process variable (%)
d07	Intelligent input terminal monitor	Displays the state of the intelligent input terminals
d08	Intelligent output terminal monitor	Displays the state of the intelligent output terminals
d09	RPM monitor	Display of output RPM
d10	Power consumption monitor	Display of power consumption
d11	Operation accumulated time(day)	Display of cumulative time (day)
d12	Operation accumulated time (minute)	Display of cumulative time (minute)

### 5.2 Trip monitor (d group)

Table 5-2 Trip monitor mode (d group)

Func-code	Name	Description
d13	Trip event monitor	Display the current trip event
d14	Trip history 1 monitor	Display the previous first trip event
d15	Trip history 2 monitor	Display the previous second trip event
d16	Trip history 3 monitor	Display the previous third trip event
d17	Trip count	Displays the trip accumulation count
d18	Inverter S/W version	Display software version of inverter
d19	Fan operation time (day)	Display fan accumulation time (day)
d20	Fan operation time (minute)	Display fan accumulation time (minute)

## 5.3 Basic function (F group)

Table 5-3 Basic function mode (F group)

Func-code	Name	Range	Defaults	Runtime edit
F01	Output frequency setting	0.00~400.0[Hz] Sensorless 0.00~300.0 [Hz]	0.00Hz	○
F02	Acceleration time 1 setting	0.0 ~ 6000.0 [sec]	5.0 sec	○
F03	Deceleration time 1 setting	0.0 ~ 6000.0 [sec]	10.0 sec	○
F04	Rotation direction setting	0 - Forward 1 - Reverse	0	X
F05	Rotation direction selection	0 - Enable both way (FW and RV) 1 - Disable forward 2 - Disable reverse	0	X
F06	Define custom display	0 ~ 65535	1.0	○

## 5.4 Extended function A mode (A group)

Table 5-4 Extended function A mode (A group)

Func-code	Name	Range	Defaults	Runtime edit	
<b>Basic parameter setting</b>					
A01	Frequency command (Multi-speed command method)	0 - Keypad potentiometer 1 - Control terminal input 2 - Standard operator 3 - Remote operator (1 <sup>st</sup> communication -RJ45) 4 - Remote operator (2 <sup>nd</sup> communication - terminal) 5 - Option 6 - Potentiometer and remote	1	X	
A02	Run command	0 - Standard operator 1 - Control terminal input 2 - Remote operator (RJ45) 3 - Remote operator (Terminal) 4 - Option	1	X	
A03	Base frequency setting	0.00 ~ Max. frequency(A04) [Hz]	60.00Hz	X	
A04	Maximum frequency setting	Base frequency (A03) ~ 400 [Hz] In case of sensorless vector (A31=2), Base frequency (A03) ~ 300 [Hz]	60.00Hz	X	
<b>Analog Input Settings (External frequency setting)</b>					
A05	External frequency setting start (O, OI)	0.00 ~ Max. frequency (A04) [Hz]	0.00Hz	X	
A06	External frequency Setting end (O, OI)	0.00 ~ Max. frequency (A04) [Hz]	0.00Hz	X	
A07	External frequency start rate setting (O, OI)	0.0~100.0 [%]	0.0%	X	
A08	External frequency start rate setting (O, OI)	0.0~100.0 [%]	100.0%	X	
A09	External frequency start pattern setting	0 - Start at start frequency (A05) 1 - Start at 0 Hz	0	X	
A10	External frequency sampling setting	1~5000	10	X	



Func-code	Name	Range	Defaults	Runtime edit
<b>Multi-speed Frequency Setting</b>				
A11 ~ A25	Multi-speed frequency setting	0.00 ~ Max. frequency (A04) [Hz]	speed1:5Hz speed2:10Hz speed3:15Hz speed4:20Hz speed5:30Hz speed6:40Hz speed7:50Hz speed8:60Hz etc. 0Hz	○
A26	Jogging frequency setting	0.50~10.00 [Hz]	0.50Hz	○
A27	Jogging stop operation selection	0 - Free-run stop 1 - Deceleration stop (depending on deceleration time) 2 - DC injection braking stop (necessary to set DC injection braking)	0	X
<b>V/F Characteristics</b>				
A28	Torque boost mode selection	0 - Manual torque boost 1 - Automatic torque boost * For use automatic torque boost, Need to set for motor (H group)	0	X
A29	Manual torque boost Setting (forward)	0.0~50.0 [%]	(Note 1)	○
A30	Manual torque boost Setting (reverse)	0.0~100.0 [%]	100.0%	○
A31	V/F characteristic curve selection	0 - Constant torque 1 - Reduced torque (reduction of the 1.7thpower) 2 - Sensorless vector control 3 - VF_USER	0	X
A32	V/F gain setting	20.0~110.0 [%]	100.0%	○

(Note 1) Depends on inverter power range

200V Class - 5.5kW:4.9[%], 7.5kW:4.4[%], 11kW:3.5[%], 15kW:2.8[%]

400V Class - 5.5kW:4.9[%], 7.5kW:4.4[%], 11kW:3.5[%], 15kW:2.8[%], 18.5kW:2.5[%], 22kW:2.5[%]

Func-code	Name	Range	Defaults	Runtime edit
<b>DC Injection Braking Settings</b>				
A33	DC injection braking function selection	0 – Disable 1 – Enable	0	X
A34	DC injection braking Frequency setting	0.50~10.00 [Hz]	0.50Hz	X
A35	DC injection braking output delay time setting	0.0~5.0 [sec]	0.0 sec	X
A36	DC injection braking force setting	0.0~100.0 [%]	(Note2)	X
A37	DC injection braking time setting	0.0~10.0 [sec]	0.0 sec	X
<b>Frequency-related Functions</b>				
A38	Frequency upper limit setting	Frequency lower limit (A39) ~ Max. frequency (A04) [Hz]	0.00Hz	X
A39	Frequency lower limit setting	0.00~Frequency upper limit (A38) [Hz]	0.00Hz	X
A40 A42 A44	Jump(center)frequency setting	0.00~ Max. frequency (A04) [Hz]	0.00Hz	X
A41 A43 A45	Jump(hysteresis) frequency width setting	0.00~10.00 [Hz]	0.00Hz	X
A46	Manual torque boost (Reverse)	0.0~50.0[%]	(Note 3)	O
A47	Manual torque boost Frequency setting (Reverse)	0.0~100.0[%]	100.0%	O

(Note 2) 50.0% ( $\leq 22\text{kW}$ )

(Note 3) Depends on inverter power range

200V Class – 5.5kW:4.9[%], 7.5kW:4.4[%], 11kW:3.5[%], 15kW:2.8[%]

400V Class – 5.5kW:4.9[%], 7.5kW:4.4[%], 11kW:3.5[%], 15kW:2.8[%], 18.5kW:2.5[%], 22kW:2.5[%]

Func-code	Name	Range	Defaults	Runtime edit
<b>Automatic Voltage Regulation (AVR) Function</b>				
A52	AVR function selection	0 - Constant ON 1 - Constant OFF 2 - OFF during deceleration	2	X
A53	Motor input voltage setting	200V Class -80~240V 400V Class -160~500V	(Note 4)	X
<b>Second Acceleration and Deceleration Functions</b>				
A54	Second acceleration time setting	0.0~6000 [sec]	30.0 sec	○
A55	Second deceleration time setting	0.0~6000 [sec]	30.0 sec	○
A56	Two stage acc1/dece1 switching method selection	0 - 2CH input from terminal 1 - Transition frequency from acc/dec1 to acc/dec2	0	X
A57	Acc1 to Acc2 frequency transition point <sup>note5</sup>	0.00~Max. frequency (A04) [Hz]	0.00Hz	X
A58	Decel 1 to Decel 2 frequency transition point <sup>note5</sup>	0.00~Max. frequency (A04) [Hz]	0.00Hz	X
A59	Acceleration curve selection	0 - Linear 1 - S curve 2 - U curve	0	X
A60	Deceleration curve setting	0 - Linear 1 - S curve 2 - U curve	0	X
<b>Others</b>				
A61	Input voltage offset setting	-10.0~10.0 [%]	0.0%	○
A62	Input voltage gain setting	0.0~200.0 [%]	100.0%	○
A63	Input current offset setting	-10.0~10.0 [%]	0.0%	○
A64	Input current gain setting	0.0~200.0 [%]	100.0%	○
A65	FAN operation mode	0 - Always ON 1 - ON in the run time	0	X

(Note 4) LF/LFP: 220V, 055HF/075HFP~220HF/300HFP: 380V

(Note 5) If the acceleration and deceleration times are set to a value less than or equal to 1 second, the saving frequency will be inaccurate.

Func-code	Name	Range	Defaults	Runtime edit	
<b>S curve ratio setting</b>					
A66	S curve start ratio setting of acceleration	0.0~100.0[%]	50.0%	○	
A67	S curve stop ratio setting of acceleration	0.0~100.0[%]	50.0%	○	
A68	S curve start ratio setting of deceleration	0.0~100.0[%]	50.0%	○	
A69	S curve stop ratio setting of deceleration	0.0~100.0[%]	50.0%	○	
<b>PID Control</b>					
A70	PID Function selection	0 - PID control disable 1 - PID control enable 2 - F/F control enable	0	X	
A71	PID Reference	0.00 ~ 100.00 [%]	0.00%	○	
A72	PID Reference source	0 - Keypad potentiometer 1 - Control terminal input 2 - Standard operator 3 - Remote operator (RJ45) 4 - Remote operator (Terminal) 5 - Option 6 - Potentiometer and RJ45	6	X	
A73	PID Feed-back source	0 - Current input (OI) 1 - Voltage input (O)	0	X	
A74	PID P gain	0.1 ~ 1000.0 [%]	100.0%	○	
A75	PID I gain	0.0 ~ 3600.0 [sec]	1.0sec	○	
A76	PID D gain	0.00 ~ 10.00 [sec]	0.00sec	○	
A77	PID Err limit	0.0 ~ 100.0 [%]	100.0%	○	
A78	PID Output high limit	PID Output low limit (A79) ~ 100.0 [%]	100.0%	○	

Func-code	Name	Range	Defaults	Runtime edit
A79	PID Output low limit	-100.0 ~ PID Output high limit (A78) [%]	0.0%	○
A80	PID Output reverse	0 - PID output reverse disable 1 - PID output reverse enable	0	X
A81	PID scale factor	0.1 ~ 1000.0 [%]	100.0%	X
A82	Pre PID frequency	0.00 ~ Max. frequency(A04) [Hz]	0.00Hz	X
A83	Sleep frequency	0.00 ~ Max. frequency(A04) [Hz]	0.00Hz	X
A84	Sleep/wake up delay time	0.0 ~ 30.0 [sec]	0.0sec	X
A85	Wake up frequency	0.00 ~ Max. frequency(A04) [Hz]	0.00Hz	X
<b>Set user V/F pattern ratio</b>				
A86	User V/F setting frequency 1	0 ~ V/F setting frequency 2 (A88)	15.00Hz	X
A87	User V/F setting voltage 1	0 ~ V/F setting voltage 2 (A89)	25.0%	X
A88	User V/F setting frequency 2	V/F setting frequency 1 (A86) ~ V/F setting frequency 3 (A90)	30.00Hz	X
A89	User V/F setting voltage 2	V/F setting voltage 1 (A87) ~ V/F setting voltage 3 (A91)	50.0%	X
A90	User V/F setting frequency 3	V/F setting frequency 2 (A88) ~ V/F setting frequency 4 (A92)	45.00Hz	X
A91	User V/F setting voltage 3	V/F setting voltage 2 (A89) ~ V/F setting voltage 4 (A93)	75.0%	X
A92	User V/F setting frequency 4	V/F setting frequency 3 (A90) ~ Max. frequency (A04)	60.00Hz	X
A93	User V/F setting voltage 4	V/F setting voltage 3 (A91) ~ 100.0 [%]	100.0%	X

## 5.5 Extended function b mode (b group)

Table 5-5 Extended function b mode (b group)

Func-code	Name	Range	Defaults	Runtime edit
<b>Restart Mode</b>				
b01	Selection of restart mode	0 – Alarm output after trip 1 – Restart at 0Hz 2 – Resume operation after frequency matching 3 – Resume previous freq. after freq. matching, then decelerate to stop. And display trip info.	0	X
b02	Allowable instantaneous power failure time setting	1.0~10.0 [sec]	2.0 sec (Note 6)	X
b03	Reclosing standby after instantaneous power failure recovered	0.3~10 [sec]	1.0 sec	X
<b>Electronic Thermal Setting</b>				
b04	Electronic thermal level setting	Motor rated current x 20.0%~ 120.0%	100.0%	X
b05	Electronic thermal characteristic, selection	0 – Cooling fan is mounted on the motor shaft (Self-cool) 1 – Cooling fan is powered by external source (Forced-cool)	1	X
<b>Overload Restriction</b>				
b06	Overload overvoltage Restriction mode selection	0 – Overload restriction mode OFF 1 – Overload restriction mode ON * Overvoltage setting is b67	1	X.
b07	Overload restriction level setting (constant speed)	Set Between 20%~200% of rated current of inverter HD: 20.0%~ 200.0% ND: 20.0%~ 165.0% * If there is speed change, you can set at b49	HD:180% ND:150%	X
b08	Overload restriction constant setting	0.1~10.0 [sec]	10.0 sec	X

(Note 6) Allowable instantaneous power failure time is depending on machine or load conditions. So, please check and verification test before using.

Func-code	Name	Range	Defaults	Runtime edit
<b>Others</b>				
b09	Software lock mode selection	0 – All parameters locked (Except b09, when SFT from terminal is on) 1 – All parameters locked (Except b09 and F01, when SFT from terminal is ON) 2 – All parameters locked (Except b09, when function set) 3 – All parameters locked (Except b09 and F01, when function set) 4 – All parameters locked (Except b09, F01, F02, F03, when function set)	0	X
b10	Start frequency Adjustment	0.50~10.00 [Hz]	0.50Hz	X
b11	Carrier frequency setting	1.0~10.0[kHz] (5.5kW~22kW)	5.0kHz	○
b12	Initialization mode	0 – Trip history clear 1 – Parameter initialization	0	X
b13	Country code for initialization	0 – Korean version 1 – Europe version 2 – US version	0	X
b14	RPM conversion factor setting	0.01~99.99	1.00	○
b15	STOP key validity during terminal operation	0 – STOP enable 1 – STOP disable	0	X
b16	Resume on FRS cancellation mode	0 – Restart from 0Hz 1 – Restart from frequency detected from real speed of motor	0	X
b17	Communication number	1~32 [count]	1	X
b18	Ground fault setting (Note7)	0.0~100.0 [%] 0 – Do not detect ground fault.	0.0%	X

(Note 7) Below 22kW, disable ground fault setting. (value is always 0)  
Upper 30kW, able to use as above range.

Func-code	Name	Range	Defaults	Runtime edit
b19	Speed Search Current Suppression Level	0.0~30.0[sec]	2.0 sec	<input type="radio"/>
b20	Voltage increase Level during Speed Search	0.1~10.0[sec]	1.0 sec	<input type="radio"/>
b23	Frequency match operation selection	0 - 0Hz Starting operation 1 - Frequency matching & start operation	0	<input type="radio"/>
b24	Failure status output selection by relay in case of failure	0 - Inactive at low voltage failure 1 - Active at voltage failure (Inactive at restart mode) 2 - Active of all failure occurred 3 - Active at voltage failure (For low voltage failure, automatic restart)	0	<input type="radio"/>
b25	Stop method selection	0 - Decelerating stop 1 - Free run stop	0	<input type="radio"/>
b26	Inverter type change to P-type (Normal Duty)	0 - Heavy Duty (Standard Type) 1 - Normal Duty (P-Type)	0	X
b27	Input phase loss	0~30 [sec] 0 - Disable	10 sec	<input type="radio"/>
b28	Communication time out setting	0~60 [sec] 0 - Disable	0 sec	<input type="radio"/>
b29	Communication time out operation mode	0 - Always active 1 - Active in case of inverter is running	0	<input type="radio"/>
b30	Display code setting	1~13	1	<input type="radio"/>
b31	2 <sup>nd</sup> communication channel 485 communication speed setting	1 - 2400 [bps] 2 - 4800 [bps] 3 - 9600 [bps] 4 - 19200 [bps] 5 - 38400 [bps]	3	<input type="radio"/>



Func-code	Name	Range	Defaults	Runtime edit	
<b>BRD (Dynamic braking) Function</b>					
b32	BRD selection	0 - Disable 1 - Enable only during inverter running 2 - Enable	1	X	
b33	BRD using ratio	0~50 [%] (5.5kW~22kW)	10%	X	
<b>Overvoltage Suppression (OVS) Function</b>					
b34	Maximum OVS output frequency	0.00~300.00 [Hz]	20.00Hz	O	
b35	OVS P gain	0~100.00 [%]	10.00%	O	
b36	OVS I gain	0~100.00 [%]	1.00%	O	
b37	OVS D gain	0~100.00 [%]	1.00%	O	
b38	Q axis reference	-100.0~100.0	0	O	
b39	Filter bandwidth	0~1000	1	O	
b40	Overvoltage suppression	0 - Disable 1 - Enable for current 2 - Enable for voltage	0	O	
b41	Limit Time	0.0~100.0 [sec]	0.5 sec	O	
<b>DC Injection Braking</b>					
b42	VFD start delay time after DC Injection braking	0.0~60.0 [sec]	0.0 sec	X	
b43	DC Injection braking time at start	0.0~6000.0[sec]	0.0 sec	O	
b44	Current controller P gain in DC braking	0~100.00 [%]	5.00%	O	
b45	Current controller I Gain time in DC braking	0~100.00 [%]	5.00%	O	
b46	DC Injection braking force	0.0~100.0[%] of inverter rated current	50.0%	O	
<b>Overload Restriction</b>					
b49	Overload restriction level at acceleration & deceleration	HD: 20.0%~ 200.0% ND: 20.0%~ 165.0%	HD:180% ND:150%	O	

Func-code	Name	Range	Defaults	Runtime edit	
<b>Droop Control function</b>					
b50	Droop control start freq.	0.00 ~ Max. frequency (A04) [Hz]	0.00Hz	○	
b51	Droop control standard freq.	10.00 ~ Max. frequency (A04) [Hz]	60.00Hz	○	
b52	Droop control gain	0.00~50.00 [%]	5.00%	○	
b53	Droop star torque	0.0~100.0 [%]	0.0%	○	
b54	Droop acceleration time	1.0~100.0 [sec]	20sec	○	
b55	Droop control mode	0 - Disable 1 - Enable	0	○	
<b>Motor Load Detection Function</b>					
b56	Motor load detection selection	0 - Disable 1 - Overload detection 2 - Underload detection 3 - Overload/Underload detection 4 - Overload detection with fault (E23) 5 - Underload detection with fault (E24) 6 - Overload/Underload detection with fault (E23, E24)	0	X	
b57	Motor overload detection level	20.0~200.0 [%] of motor rated current	100.0%	X	
b58	Motor underload detection level	20.0~200.0 [%] of motor rated current	100.0%	X	
b59	Overload/Underload detection time	0.0~60.0 [sec]	10.0sec	X	
b60	Overload/Underload detection safe zone	0.00 ~ Max. frequency (A04) [Hz]	0.00Hz	X	
<b>Dwell Function</b>					
b61	Dwell frequency at start	0.00 ~ Max. frequency (A04) [Hz]	0.00Hz	○	
b62	Dwell time at start	0.0~10.0 [sec]	0.0sec	○	
b63	Dwell frequency at stop	0.00 ~ Max. frequency (A04) [Hz]	0.00Hz	○	
b64	Dwell time at stop	0.0~10.0 [sec]	0.0sec	○	

Func-code	Name	Range	Defaults	Runtime edit	
<b>KEB Function</b>					
b65	KEB control selection	0 – Disable 1 – Enable	0	X	
b66	KEB control gain	0.1~100.0[%]	10.0%	X	
<b>Overcurrent Restriction</b>					
b67	Overcurrent selection	0 – Disable 1 – Enable	1	X	
b68	Overcurrent time at running	0.0~60.0 [sec]	0.0sec	O	
b69	Stop frequency setting	0.00 ~ Max. frequency (A04) [Hz]	0.00Hz	O	
b70	Overcurrent time at stop	0.0~60.0 [sec]	0.0sec	O	
<b>Display Function</b>					
b71	User parameter setting	1 – Output frequency monitor 2 – Output current monitor 3 – Output voltage monitor 4 – Rotation direction monitor 5 – PID feedback monitor 6 – Intelligent terminal input monitor 7 – Intelligent terminal output monitor 8 – RPM monitor 9 – Power consumption monitor 10 – Display of cumulative time (day) 11 – Display of cumulative time (minute) 12 – DC link voltage	1	O	
b72	User mathematical sign	0 – '+' calculation 1 – '-' calculation 2 – 'X' calculation 3 – '/' calculation	0	O	
b73	Define user setting	0.01~600.00	1.00	O	

## 5.6 Extended function C mode (C group)

Table 5-6 Extended function C mode (C group)

Func-code	Name	Range	Defaults	Runtime edit
<b>입력단자 기능</b>				
C01	Intelligent input terminal 1 setting	0 - FW (Forward run command) 1 - RV (Reverse run command) 2 - CF1 (1 <sup>st</sup> multi speed command) 3 - CF2 (2 <sup>nd</sup> multi speed command) 4 - CF3 (3 <sup>rd</sup> multi speed command) 5 - CF4 (4th multi speed command)	0	X
C02	Intelligent input terminal 2 setting	6 - JG (Jogging operation command) 8 - 2CH (2 stage accel/decel command) 9 - FRS (Free run stop command) 10 - EXT (External trip) 11 - USP (Unattended Start Protection)	1	X
C03	Intelligent input terminal 3 setting	12 - SFT (Software lock) 13 - AT (Analog input current/voltage selection signal) 14 - RS (Reset) 15 - STA (Start) 16 - STP (Keep)	2	X
C04	Intelligent input terminal 4 setting	17 - F/R (Forward/Reverse) 18 - UP (Remote control UP) 19 - DOWN (Remote control DOWN) 20 - O/R (Local keypad operation) 21 - T/R (Local terminal input operation)	3	X
C05	Intelligent input terminal 5 setting	22 - PIDIR (PID Integral reset) 23 - PIDD (PID Disable) 24 - Add A11 to setting frequency 25 - Cancel add A11 26 - External alarm 2	13	X
C06	Intelligent input terminal 6 setting	27 - External alarm 3 28 - External alarm 4 29 - External alarm 5 30 - External alarm 6 31 - Up/Down Value Clear	14	X

Func-code	Name	Range	Defaults	Runtime edit
<b>Input Terminal Status</b>				
C07	Input terminal 1 a/b contact setting (NO/NC)	0 - a contact (Normal open) [NO] 1 - b contact (Normal close) [NC]	0	X
C08	Input terminal 2 a/b contact setting (NO/NC)		0	X
C09	Input terminal 3 a/b contact setting (NO/NC)		0	X
C10	Input terminal 4 a/b contact setting (NO/NC)		0	X
C11	Input terminal 5 a/b contact setting (NO/NC)		0	X
C12	Input terminal 6 a/b contact setting (NO/NC)		0	X
<b>Output Terminal and Related Function</b>				
C13	Replay output(30A/30B/30C) terminal setting	0 - RUN (Run signal) 1 - FA1 (Frequency command arrival) 2 - FA2 (Setting frequency or more) 3 - OL (Overload advance notice) 4 - OD (Output deviation for PID) 5 - AL (Alarm signal) 6 - MO (Modbus communication) 7 - SOL (System Overload) 8 - SUL (System Underload) 9 - SOL/SUL (System Overload/Underload detection)	5	X
C14	Open collector output (11-CM2) terminal setting	10 - AI Loss 11 - Keypad alarm 12 - Control external braking	1	X
C15	Open collector output (12-CM2) terminal setting		0	X
C16	Output terminal 11 - CM2 a/b contact setting	0 - a contact (Normal open) [NO] 1 - b contact (Normal close) [NC]	0	X
C17	Output terminal 12 - CM2 a/b contact setting		0	X
C18	FM output selection	0 - Output frequency monitor 1 - Output current monitor 2 - Output voltage monitor 3 - Output electric power monitor 4 - Output torque monitor 5 - Control by Modbus communication 6 - DC voltage	0	X
C19	FM gain adjustment	0~250.0 [%]	100.0%	○
C20	FM offset adjustment	-3.0~10.0 [%]	0.0%	○

Func-code	Name	Range	Defaults	Runtime edit	
C21	Overload advance notice signal level setting	10.0~200.0 [%] of rated current	100.0%	X	
C22	Acceleration arrival signal frequency setting	0.00~Max. frequency (A04) [Hz]	0.00Hz	X	
C23	Deceleration arrival signal frequency setting	0.00~Max. frequency (A04) [Hz]	0.00Hz	X	
C24	PID deviation level setting	0.0~100.0 [%]	10.0%	X	
C25	AMI output selection	0 - Output frequency monitor 1 - Output current monitor 2 - Output voltage monitor 3 - Output electric power monitor 4 - Output torque monitor 5 - Control by Modbus communication 6 - DC voltage	1	X	
C26	AMI gain adjustment	0 ~ 250.0%	100.0%	○	
C27	AMI offset adjustment	-99.9 ~ 100.0%	0.0%	○	
<b>Up/Down Function</b>					
C28	Up/Down value saving selection	0 - Disable 1 - Enable	0	X	
C29	Up/Down initial value setting	0 ~ Max. frequency [A04]	0	○	
C30	Up/Down Acc/decel time setting	0.1~3000.0[sec]	10.0sec	○	
C31	Up/Down function selection	0 - Disable 1 - Enable	0	X	
C32	Up/Down value setting	0.00~400.00[%]	0	○	
<b>Keypad/Communication fault</b>					
C33	Decel time at fault occur	0.0~6000.0[sec]	10.0sec	○	
C34	Selection of running state when keypad connection failed	0 - Run 1 - Stop	0	X	
C35	Selection of keypad detection	0 - Disable 1 - Abnormal move detection 2 - Detect keypad fault and occur E61 3 - Detect abnormal move and occur E61	0	○	

Func-code	Name	Range	Defaults	Runtime edit	
C36	Selection of communication or analog speed command failure detection	0 - Disable 1 - Loss frequency (50%) (Less than 50% of A07) 2 - Loss frequency (100%) (Under than A07) 3 - Loss frequency when speed command by RS485	0	○	
C37	Selection of run command when speed losing	0 - Disable 1 - Free run stop (Output block) 2 - Stop 3 - Run by C38 frequency	0	○	
C38	Waiting time in case of frequency command loss	0.0~120.0[sec]	1.0sec	○	
C39	Frequency setting in case of analog command loss	0.00 ~ Max. frequency [A04]	30.00Hz	○	
<b>Overload Caution Time</b>					
C40	Overload caution time	Detection time of overload advance notice signal level (C21) 0.0~30.0[sec]	10.0sec	○	
<b>External Brake Function</b>					
C41	Current of external brake	0.0~200.0 [%] of rated current	100.0%	○	
C42	Frequency of external brake	0.00 ~ 25.00[Hz]	10.00Hz	○	
C43	Timer of external brake	0.0 ~ 5.0[sec]	1.0sec	○	
C44	Stop frequency of external brake	0.00 ~ 25.00[Hz]	10.00Hz	○	
C45	Stop timer of external brake	0.0 ~ 5.0[sec]	1.0sec	○	

## 5.7 Motor (H group)

Table 5-7 Motor setting (H group)

Func-code	Name	Runtime edit	Range	Default																								
H01	Auto-tuning mode selection	X	0 - Auto-tuning OFF 1 - Auto-tuning ON	0																								
H02	Motor data selection	X	0 - Standard motor data 1 - Use auto-tuning data	0																								
H03	Motor capacity	X	<table border="0"> <tr> <td>0 - MOT_004LF</td> <td>12 - MOT_004HF</td> </tr> <tr> <td>1 - MOT_007LF</td> <td>13 - MOT_007HF</td> </tr> <tr> <td>2 - MOT_015LF</td> <td>14 - MOT_015HF</td> </tr> <tr> <td>3 - MOT_022LF</td> <td>15 - MOT_022HF</td> </tr> <tr> <td>4 - MOT_037LF</td> <td>16 - MOT_037HF</td> </tr> <tr> <td>5 - MOT_055LF</td> <td>17 - MOT_055HF</td> </tr> <tr> <td>6 - MOT_075LF</td> <td>18 - MOT_075HF</td> </tr> <tr> <td>7 - MOT_110LF</td> <td>19 - MOT_110HF</td> </tr> <tr> <td>8 - MOT_150LF</td> <td>20 - MOT_150HF</td> </tr> <tr> <td>9 - MOT_185LF</td> <td>21 - MOT_185HF</td> </tr> <tr> <td>10- MOT_220LF</td> <td>22 - MOT_220HF</td> </tr> <tr> <td>11- MOT_300LF</td> <td>23 - MOT_300HF</td> </tr> </table>	0 - MOT_004LF	12 - MOT_004HF	1 - MOT_007LF	13 - MOT_007HF	2 - MOT_015LF	14 - MOT_015HF	3 - MOT_022LF	15 - MOT_022HF	4 - MOT_037LF	16 - MOT_037HF	5 - MOT_055LF	17 - MOT_055HF	6 - MOT_075LF	18 - MOT_075HF	7 - MOT_110LF	19 - MOT_110HF	8 - MOT_150LF	20 - MOT_150HF	9 - MOT_185LF	21 - MOT_185HF	10- MOT_220LF	22 - MOT_220HF	11- MOT_300LF	23 - MOT_300HF	-
0 - MOT_004LF	12 - MOT_004HF																											
1 - MOT_007LF	13 - MOT_007HF																											
2 - MOT_015LF	14 - MOT_015HF																											
3 - MOT_022LF	15 - MOT_022HF																											
4 - MOT_037LF	16 - MOT_037HF																											
5 - MOT_055LF	17 - MOT_055HF																											
6 - MOT_075LF	18 - MOT_075HF																											
7 - MOT_110LF	19 - MOT_110HF																											
8 - MOT_150LF	20 - MOT_150HF																											
9 - MOT_185LF	21 - MOT_185HF																											
10- MOT_220LF	22 - MOT_220HF																											
11- MOT_300LF	23 - MOT_300HF																											
H04	Motor poles setting	X	2~48[P]	4																								
H05	Motor rated current	X	Range is 0.1 - 800.0 [A]	-																								
H06	Motor no-load current (I <sub>0</sub> )	X	Range is 0.1 - 400.0 [A]	-																								
H07	Motor rated slip	X	Range is 0.01 - 20.0 [Hz]	-																								
H08	Motor Resistance R1	X	Range is 0.1 - 3000.00 [mΩ]	-																								
H09	Transient Inductance	X	Range is 0.001 - 30.000 [mH]	-																								
H10	Motor ResistanceR1	X	Range is 0.1 - 3000.00 [mΩ]	-																								
H11	Transient Inductance auto tuning data	X	Range is 0.001 - 30.000 [mH]	-																								
H12	State of Auto-tuning	O	0:AT_READY 1:AT_RSTUNE 2:AT_LSIGMATUNE 3:AT_TRTUNE 4:AT_LSTUNE 5:AT_ENDING 6:AT_ENDAT	0																								



## 6. COMMUNICATION

iMaster C1 offers two communication interfaces between the inverter and external controller through RS485. Use RJ-45 modular connector and RXP, PXN as second way. By communication, the main controller (iMaster C1) can control 1~32 pcs controllers as slave.

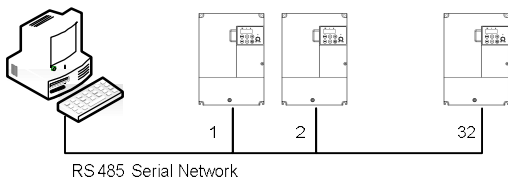

RS485 Serial Network  
**Figure 6-1 RS485 Serial Communication Network**

### ■ RS485 Communication specification

Item	Description	Remark
Interface	RS485	
Communication method	Half duplex	
Communication speed	9600 (1 <sup>st</sup> RJ-45) 2400~38400 (2 <sup>nd</sup> terminal)	Fixing Changeable setting(b31)
Communication code	Binary code	
Date bit	8	Fixing
Parity	No	Fixing
Stop bit	1	Fixing
Starting method	External request	Inverter is only slave part
Wait time	10~1000ms	
Connection type	1: N (Max 32) (Note1)	
Error check	Frame/CRC/CMD/MAXREQ/Parameter	Communication number is selected at b17

(Note 1) Depending on the installation environment, there is a high probability of communication malfunction due to wiring type, wiring method, and other noise. For reliable communication, we recommend fewer than 16 connections.

■ RJ45 specification (1<sup>st</sup> Communication)

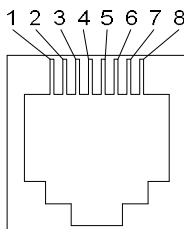

Pin No.	Signal Descriptions
1	
2	
3	RS - 485+
4	
5	
6	RS - 485-
7	24V
8	24V GND

■ Terminal specification (2<sup>nd</sup> communication)

Name	Description
RXP	RS485 (+)
RXN	RS485 (-)

■ RS485 related code

Func-code	Range	Default	Setting
b17	1 ~ 32	1	Setting communication number
b31	1 - 2400 [bps] 2 - 4800 [bps] 3 - 9600 [bps] 4 - 19200 [bps] 5 - 38400 [bps]	3	Setting 485 and 2 <sup>nd</sup> communication speed
A01	0 - Keypad potentiometer 1 - Control input terminal 2 - Standard operator 3 - Remote (1 <sup>st</sup> communication RJ45) 4 - Remote (2 <sup>nd</sup> communication Terminal) 5 - Option 6 - Potentiometer and remote	1	
A02	0 - Keypad potentiometer 1 - Control input terminal 2 - Remote (1 <sup>st</sup> communication RJ45) 3 - Remote 2 <sup>nd</sup> communication Terminal) 4 - Fieldbus (option)	1	

## ■ Communication sequence

The communication sequence is as follows.

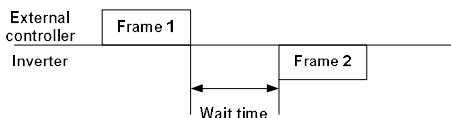

Frame start: Frame start is recognized by signal line data transmitted.

Frame completion: Frame completion is recognized by no data during correspond 4, 5-character time.

Frame 1: Transmit from external controller to inverter.

Frame 2: Indication reflects from inverter to external controller

## ■ Communication frame type and form

### ● External controller transmit frame

Communication number	Command	Parameter	Parameter count	CRC Hi	CRC Lo
----------------------	---------	-----------	-----------------	--------	--------

	Description	Data size	Specifications
Communication number	Inverter communication number	1 byte	1~32
Command	Frame type	1 byte	0x03
Parameter	Parameter	2 bytes	1 <sup>st</sup> byte: Group 2 <sup>nd</sup> byte: Index
Parameter count	Request parameter number(count)	2 bytes	1 <sup>st</sup> byte: 0x00 2 <sup>nd</sup> byte: N(0x01~0x08)
CRC Hi	-	1 byte	Higher 8bit of 16bit CRC
CRC Lo	-	1 byte	Lower 8bit of 16bit CRC

### ● Inverter response frame

Communication number	Command	Byte Number	Data 1	...	Data N	CRC Hi	CRC Lo
----------------------	---------	-------------	--------	-----	--------	--------	--------

	Description	Data size	Specifications
Communication number	Inverter communication number	1 byte	1~32
Command	Frame type	1 byte	0x03
Byte Number	Data Byte Number	1 byte	Request parameter * 2
Data 1	Parameter 1	2 bytes	Parameter value
Data N	Parameter N	2 bytes	Nth parameter value
CRC Hi	-	1 byte	Higher 8bit of 16bit CRC
CRC Lo	-	1 byte	Lower 8bit of 16bit CRC

\* Frame Size = 5 + Request parameter number x 2

### ■ Parameter frame type and form

Set 1 parameter and command to inverter.

#### ● External transmit frame

Communication number	Command	Parameter	Data	CRC Hi	CRC Lo
	Description	Data size	Specifications		
Communication number	Target inverter communication number	1 byte	1~32		
Command	Frame type	1 byte	0x06		
Parameter	Parameter	2 bytes	1 <sup>st</sup> byte: Group 2 <sup>nd</sup> byte: Index <small>(Note 1)</small>		
Data	Data	2 bytes	Setting value <small>(Note 2)</small>		
CRC Hi	-	1 byte	Higher 8bit of 16bit CRC		
CRC Lo	-	1 byte	Lower 8bit of 16bit CRC		

#### ● Inverter response frame

Communication number	Command	Parameter	Data	CRC Hi	CRC Lo
	Description	Data size	Specifications		
Communication number	Target inverter communication number	1 byte	1~32		
Command	Frame type	1 byte	0x06		
Parameter	Parameter	2 bytes	1 <sup>st</sup> byte: Group 2 <sup>nd</sup> byte: Index <small>(Note 1)</small>		
Data	Data	2 bytes	Setting value <small>(Note 3)</small>		
CRC Hi	-	1 byte	Higher 8bit of 16bit CRC		
CRC Lo	-	1 byte	Lower 8bit of 16bit CRC		

#### (Note 1) Parameter setting

##### 1) Basic parameter

Set each group to 1<sup>st</sup> byte and set the parameter number to 2<sup>nd</sup> byte.

For example, A60 parameter reading or writing, set 0x03 to 1<sup>st</sup> byte and 0x3C to 2<sup>nd</sup> byte.

1 <sup>st</sup> byte		2 <sup>nd</sup> byte
Group	Set	Parameter number
d	0x01	
F	0x02	
A	0x03	
B	0x04	
C	0x05	
H	0x06	

Trip information is 4 parameters.

(output frequency, output current, DC link voltage at trip occurs)

	Trip information (d13)	Previous first trip (d14)	Previous second trip (d15)	Previous third trip (d16)	Trip count (d17)
1 <sup>st</sup> byte	0x01	0x01	0x01	0x01	0x01
2 <sup>nd</sup> byte	0x0D	0x11	0x15	0x19	0x1D

#### ※ Trip information data

Trip data	Description	Trip data	Description
1	Over current trip	19	OVS fail
2	Over voltage trip	20	HW power trip 1
3	Under voltage trip	21	HW power trip 2
4	Arm short trip	22	External trip 2
5	Reserved	23	External trip 3
6	Inverter over heat	24	External trip 4
7	Electric thermal trip	25	External trip 5
8	External trip	26	External trip 6
9	EEPROM error	27	Fan trip
10	Communication error	28	Option trip (Profibus)
11	USP trip	29	Option trip (DeviceNet)
12	Ground Fault trip (Over 30kW)	30	System overload trip
15	Input phase loss	31	System underload trip
14	IOLT	32	Keypad communication trip
16	Communication error		
17	Safety function		
18	Braking resistor overload		

**(Note 2) Data value setting**

Data value is transmitted except decimal point.

(Please contact to ADT for more details)

Description	Related code	Scale	Remark
Frequency	d01, F01 etc.	0.01	Communication data 6000 Conversion hexadecimal 60 [Hz]
Acc/decel time	F02, F03 etc.	0.1	Communication data 100 Conversion hexadecimal 10 [sec]
Current	d02 etc.	0.1	Communication data 100 Conversion hexadecimal 10[A]

**(㉟3) Special parameter**

## 1) Run command

Parameter frame: 0x0002

Setting data: Forward (0x0001), Reverse (0x0002), Reset (0x0004), Stop (0x0000)

## ㉟) Forward run command frame

Description	Comm.no.	Command	Parameter	Data	CRC
Data	0x01	0x06	0x0002	0x0001	0xe9ca

## 2) Frequency command

Parameter frame: 0x0004

Setting data: Hexadecimal of (Output frequency command \* 100)

## ㉟) Frequency command (60Hz) frame

Description	Comm.no.	Command	Parameter	Data	CRC
Data	0x01	0x06	0x0004	0x1770	0xc61f

Data additional explanation: 60Hz → 6000(Scale) → 0x1770

**(Reference) 16bit CRC generation**

The step of CRC generation is as follows:

- 1) All of 16-bit Parameter is 1.0xffff
- 2) The exclusive OR of 16-bit Parameter and 8-bit Parameter.
- 3) Shift right side 1bit 16-bit Parameter
- 4) If the result of step 3 is 1, exclusive OR 16-bit Parameter and 0xa001.
- 5) Execute 8 times step 3 and step 4.
- 6) Execute step 2~6 until data completion.
- 7) Exchange the step 6 result of higher 8bit and lower 8bit.

Example) The case of d01 output frequency reading

Byte 1	Byte 2	Byte 3	Byte 4	Byte 5	Byte 6
Communication number	Command	Parameter		Parameter Number	
0x01	0x03	0x01	0x01	0x00	0x01

**The sequence of addition Byte (01x01)**

16-BIT REGISTER	MSB				Flag
(Exclusive OR)	1111	1111	1111	1111	
01	0000	0001			
	1111	1111	1111	1110	
Shift 1	0111	1111	1111	1111	
Shift 2	0011	1111	1111	1111	1
Polynomial(0xa001)	1010	0000	0000	0001	
	1001	1111	1111	1110	
Shift 3	0100	1111	1111	1111	
Shift 4	0010	0111	1111	1111	1
Polynomial(0xa001)	1010	0000	0000	0001	
	1000	0111	1111	1110	
Shift 5	0100	0011	1111	1111	
Shift 6	0010	0001	1111	1111	1
Polynomial(0xa001)	1010	0000	0000	0001	
	1000	0001	1111	1110	
Shift 7	0100	0000	1111	1111	
Shift 8	0010	0000	0111	1111	1
Polynomial(0xa001)	1010	0000	0000	0001	
	1000	0000	0111	1110	

Byte 1~6	CRC of operation results
0x01	0x807e
0x03	0x3364
0x01	0x30e1
0x01	0x8831
0x00	0xd449
0x01	0x36d4

Change upper and lower 8 bit of result 0x36d4: 0xd436

Byte7: Upper 8 bit of CRC = 0xd4

Byte8: Lower 8 bit of CRC = 0x36

## 7. PROTECTIVE FUNCTION



The various functions are provided for the protection of the inverter itself. When the protective function is occurred, motor is stopped as free-run and stay the trip once user reset the inverter.

Name	Cause(s)	Error code
Overcurrent protection	When the inverter output current exceeds the rated current during the motor locked or reduced in speed. Protection circuit activates, halting inverter output.	E04
Overload protection	When the inverter output current causes the motor to overload, the electronic thermal trip in the inverter cuts off the inverter output.	E05
Overvoltage protection	If regenerative energy from the motor or the main power supply voltage is high, the protective circuit activates to cut off the inverter output when the voltage of DC link exceeds the specification	E07
Communication error	Communication error between inverter and its operator. If the Reset signal persists for more than 4 seconds, it will occur.	E60
Under-voltage protection	When input voltage drops below the low-voltage detection level, the control circuit does not function normally. It will cause of overheat of motor and lack of torque that is why if receiving voltage is under 150~160V (200V class) or 300~320V (400V class), the inverter output is cut off.	E09
Output short-circuit	The inverter output was short-circuited. This condition causes excessive current for the inverter that is why, the inverter output is turned off.	E04 or E34
USP error	The USP error is indicated when the power is turned on with the Inverter in RUN state. (Enabled when the USP function selected)	E13
EEPROM	The inverter output is cut off when EEPROM in the inverter has an error due to external noise, excessive temperature rise, or other factors. If the error is occurred, please check setting data again. If error is occurred when power-on and does not off, please turn off the inverter at least 10minutes and power on again.	E08
External trip	When the external equipment or unit has an error, the inverter receives the corresponding signal and cuts off the output.	E12
Temperature trip	When the temperature in the main circuit increases due to cooling fan stop, the inverter output is cut off.	E21
Ground fault	When ground fault is detected on running condition, the output is cut off.	E14
Inverter overload	The power device IGBT is protected from over heat. The operating time of inverter is 1 minute with 150% load of HD or 120% load of ND. The operating time is changed depending on carrier frequency, load, ambient temperature and power rating.	E17
Input phase loss	A function that detects phase loss in the input AC source to prevent damages.	E20
Braking resistor overload protection	When BRD exceeds the usage ratio of the regenerative braking resistor, the over-voltage circuit activates and the inverter output is switched off.	E06



Name	Cause(s)	Error code
OVS fail	The OVS output frequency is higher than maximum OVS output frequency during the setting time when the OVS function is enabled.	E02
CPU error	It occurred it has error between inverter logic board and I/O board or communication error occurred. Turn off inverter completely, check there is any connection losses then power on.	E11
System overload detection fault	The output current of the drive is greater than the detection level set for this feature when it is enabled.	E23
System underload detection fault	The output current of the drive is less than the detection level set for this feature when it is enabled.	E24
FAN fault	The Fan fault is occurred, inverter output is cut off.	E33
Profibus fault (Option)	ProfibusDP optional card only. Host disconnection, or invalid host setting cause this error.	E40
DeviceNet fault (Option)	DeviceNet optional card only. Communication cable power loss, disconnect to host, or invalid host setting cause this error.	E41
HW Power fault 1	It occurred when inverter internal power is problem. Turn off power completely and try power on again.	E50
HW Power fault 2	It occurred when inverter internal power is problem. Turn off power completely and try power on again.	E51
Keypad fault	It occurred keypad communication error. Turn off power completely and try power on again.	E61
External trip 2	When the external equipment or unit has an error, the inverter receives the corresponding signal and cuts off the output. (Need setting for intelligent input terminal)	EE2
External trip 3	When the external equipment or unit has an error, the inverter receives the corresponding signal and cuts off the output. (Need setting for intelligent input terminal)	EE3
External trip 4	When the external equipment or unit has an error, the inverter receives the corresponding signal and cuts off the output. (Need setting for intelligent input terminal)	EE4
External trip 5	When the external equipment or unit has an error, the inverter receives the corresponding signal and cuts off the output. (Need setting for intelligent input terminal)	EE5
External trip 6	When the external equipment or unit has an error, the inverter receives the corresponding signal and cuts off the output. (Need setting for intelligent input terminal)	EE6

## Other display

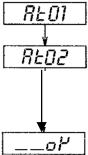
Contents	Display
It is displayed when initialization of data is processing (It is not displayed when initialization of history is processing.)	
There is no data available (Trip history, PID feedback data)	
The auto-tuning operation terminates normally	

## 8. TROUBLESHOOTING TIPS

Symptom		Probable Cause	Countermeasure
The motor will not move	The inverter outputs U, V and W are not supplying voltage	<ul style="list-style-type: none"> <li>Is the frequency command source A01 parameter setting correct?</li> <li>Is the Run command source A02 parameter setting correct?</li> </ul>	<ul style="list-style-type: none"> <li>Make sure the parameter A01 setting correct?</li> <li>Make sure the parameter A02 setting correct?</li> </ul>
		<ul style="list-style-type: none"> <li>Is power being supplied to terminals R, S and T?</li> <li>If so, the power lamp should be on.</li> </ul>	<ul style="list-style-type: none"> <li>Check terminals R, S and T then U, V, and W.</li> <li>Turn on the power supply/</li> </ul>
		<ul style="list-style-type: none"> <li>Is there an error code E□□ displayed?</li> </ul>	<ul style="list-style-type: none"> <li>Press the Func key and determine the error types.</li> <li>Then clear the error (Reset).</li> </ul>
		<ul style="list-style-type: none"> <li>Are the signals to the intelligent input terminals correct?</li> <li>Is the Run Command active?</li> <li>Is the [FW] terminal (or [RV] connected to CM1 (via switch, etc.)</li> </ul>	<ul style="list-style-type: none"> <li>Verify the terminal functions for C01-C06 are correct.</li> <li>Turn on Run Command</li> <li>Supply 24V to [FW] or [RV] terminal, if configured. (Terminal mode selection)</li> </ul>
		<ul style="list-style-type: none"> <li>Has the frequency setting for F01 been set greater than zero?</li> <li>Are the control circuit terminals H, O, and L connected to the potentiometer?</li> </ul>	<ul style="list-style-type: none"> <li>Set the parameter for F01 to a safe, non-zero value.</li> <li>If the potentiometer is the frequency setting source, verify voltage at "O" &gt; 0V</li> </ul>
		<ul style="list-style-type: none"> <li>Is the RS(reset) function or FRS (free-run stop) function on?</li> </ul>	<ul style="list-style-type: none"> <li>Turn off the command(s)</li> </ul>
	Inverter outputs U, V, W are supplying voltage	<ul style="list-style-type: none"> <li>Is the motor load too heavy?</li> <li>Is the motor locked?</li> </ul>	<ul style="list-style-type: none"> <li>Reduce load, and test the motor independently.</li> </ul>
The direction of the motor is reversed	<ul style="list-style-type: none"> <li>Are the connections of output terminal U, V, and W correct?</li> <li>Is the phase sequence of the motor forward or reverse with respect to U, V, and W?</li> </ul>	<ul style="list-style-type: none"> <li>Make connections according to the phase sequence of the motor. In general: FWD=U-V-W REV=U-W-V</li> </ul>	
	<ul style="list-style-type: none"> <li>Are the control terminals [FW] and [RV] wired correctly?</li> <li>Is parameter F04 properly set?</li> </ul>	<ul style="list-style-type: none"> <li>Use terminal [FW] for [RV] is reverse.</li> </ul>	
The motor speeds will not reach the target frequency	<ul style="list-style-type: none"> <li>If using the analog input, is the current or voltage at "O" or "OI"?</li> </ul>	<ul style="list-style-type: none"> <li>Change the wiring</li> </ul>	
	<ul style="list-style-type: none"> <li>Is the load too heavy?</li> </ul>	<ul style="list-style-type: none"> <li>Reduce the load.</li> <li>Heavy loads activate the overload restriction feature.</li> </ul>	

Symptom		Probable Cause	Countermeasure
The rotation is unstable		<ul style="list-style-type: none"> <li>•Is the load fluctuation too great?</li> <li>•Is the supply voltage unstable?</li> <li>•Is the problem occurring at a particular frequency?</li> </ul>	<ul style="list-style-type: none"> <li>•Increase the motor capacity (both inverter and motor)</li> <li>•Fix power supply problem.</li> <li>•Change the output frequency slightly, or use the jump frequency setting to skip the problem frequency.</li> </ul>
The RPM of the motor does not match the inverter output frequency setting		<ul style="list-style-type: none"> <li>•Is the maximum frequency setting A04 correct?</li> </ul>	<ul style="list-style-type: none"> <li>•Verify the V/F settings match motor specifications</li> <li>•Make sure all scaling is properly set</li> </ul>
Inverter data is not correct	No down-Load shave occurred	<ul style="list-style-type: none"> <li>•Was power turned off after a parameter edit but before pressing the store key?</li> </ul>	<ul style="list-style-type: none"> <li>•Edit the data and press the store key once</li> </ul>
		<ul style="list-style-type: none"> <li>•Edits to data are permanently stored at power down. Was the time from power off to power on less than six seconds?</li> </ul>	<ul style="list-style-type: none"> <li>•Wait six seconds or more before turning power off after edit data.</li> </ul>
A parameter is not change	The frequency setting will not change. Run/Stop does not operate	<ul style="list-style-type: none"> <li>•Was the standard operator mode and terminal mode changed correctly?</li> </ul>	<ul style="list-style-type: none"> <li>•Make sure the setting mode of [A01], [A02] (Refer to 5-4)</li> </ul>
	Parameter is not change	<ul style="list-style-type: none"> <li>•Is the SFT setting selected? SFT (b09 -2,3) selected?</li> </ul>	<ul style="list-style-type: none"> <li>•Turn off SFT function and check the b09 parameter. (b09=0)</li> </ul>

## 9. MAINTENANCE AND INSPECTION

Regularly perform maintenance and inspection. Failure to carry out regular maintenance checks will result in failure in some cases.



**DANGER**

- Wait at least ten (10) minutes after turning off the input power supply before performing maintenance of an inspection.  
Otherwise, there is the danger of electric shock.
- Make sure that only qualified personnel will perform maintenance, inspection, and part replacement. (Before starting to work, remove any metallic objects wristwatch, bracelet, etc.)  
Otherwise, there is a danger of electric shock and/or injury.

### 9.1 General precautions and notes

Always keep the unit clean so that dust of other foreign matter does not enter the inverter.

Firmly connect terminals and connectors.

Keep electronic equipment away from moisture and oil. Dust, steel filings and other foreign matter can damage insulation, causing unexpected accidents, so take special care.

When removing connectors, never pull the wires (wires for the cooling fan and logic P.C. board.)

Otherwise, there is danger of fire due to wire breakage and/or injury

### 9.2 Inspection items

- (1) Daily inspection
- (2) Periodic inspection (approximately once a year)
- (3) Insulation resistance test (approximately once two years)

Conduct the insulation resistance test by short circuiting the terminals as shown below.

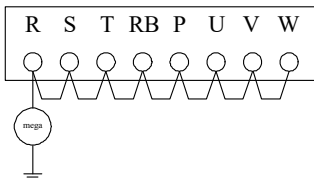

- Measure the above terminals and ground clearance with a 500 V mega tester and check if it is more than 5 MΩ.

We recommend that you stock spare parts to reduce down time, which include

### Recommend spare parts for stocks

Parts	Symbol	Quantity		Note
		Used	Spare	
Cooling Fan	FAN	1~2	1~2	Depends on power range 1EA: 055LF/075LFP~075LF/110LFP 055HF/075HFP~075HF/110HFP 2EA: 110LF/150LFP~150LF/185LFP 110HF/150HFP~220HF/300HFP
Case	-	1	1	Front case Main case Bottom case

## 9.2 Inverter electrical measurements

The following table specifies how to measure key system electrical parameters.

The diagrams on the next page show inverter-motor systems the location of measurement points for these parameters.

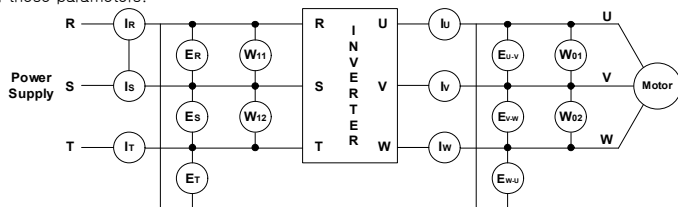

Parameter	Measurement location	Measuring instrument	Notes	Reference value
Supply voltage E1	R-S, S-T, T-R (ER) (ES) (RT)	⚡ Moving-coil type voltmeter + type voltmeter	Fundamental wave effective value	Commercial supply voltage (200V class) 200-220V 50Hz 200-240V 60Hz (400V class) 380-415V 50Hz 400-480V 60Hz
Supply current I1	R S T current (IR) (IS) (IT)	⚡ Moving-coil type ammeter	Total effective value	
Supply power W1	R-S, S-T (W11) + (W12)	⚡ Electronic type wattmeter	Total effective value	2wattmeter method
Supply power factor P <sub>f1</sub>	Calculate the output power factor from the output voltage E1, output current I1, and output power W1. $P_{f1} = \frac{W_1}{\sqrt{3} \times E_1 \times I_1} \times 100(\%)$			
Output voltage E0	U-V, V-W, W-U (EU) (EV) (EW)	*Rectifier type voltmeter	Total effective value	
Output current I0	U, V, W current (IU) (IV) (IW)	⚡ Moving-coil type ammeter	Total effective value	
Output power W0	U-V, V-W (W01) + (W02)	⚡ Electronic type wattmeter	Total effective value	2wattmeter method
Output power factor P <sub>f0</sub>	Calculate the output power factor from the output voltage E0, output current I0, and output power W0. $P_{f0} = \frac{W_0}{\sqrt{3} \times E_0 \times I_0} \times 100(\%)$			

Use a meter indicating a fundamental wave effective value for voltage, and meters indicating total effective values for current and power.

The inverter output has a PWM waveform, and low frequencies may cause erroneous readings. However, the measuring instruments and methods listed above provide comparably accurate results.

A general-purpose digital volt meter (DVM) is not usually suitable to measure a PWM waveform.

